

**KITCO**<sup>TM</sup>  
fiber optics

# Military Catalog



## Connectivity Delivered



# We've moved!

*For nearly 25 years, KITCO Fiber Optics made their home at 5269 Cleveland Street in the heart of downtown Virginia Beach.*



*In 2022 we started a new chapter in the Norfolk Industrial Park.*

*Please enjoy a few pictures of our new (new to us) location at 1151 Azalea Garden Road.*



**Sales,  
Engineering,  
Purchasing  
and  
Accounting**



**SRC**

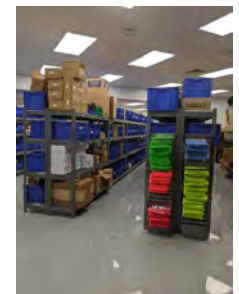

**Warehouse**

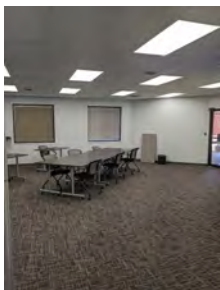

**Conference  
Room**



**Front  
Entrance**

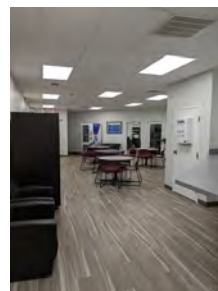

**Training  
Break  
Room**



**Training  
Classroom**

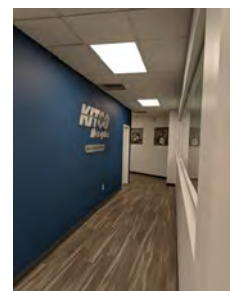

**Hallway**



**Our Mission**

Our mission is to be the leading provider of fiber optic connectorization products, training and services to the military and commercial communications industry. We will do this by exceeding our customer's expectations for service, quality and responsiveness in a way that also benefits our employees, our suppliers and our community. KITCO Fiber Optics will design and deliver products and provide services at the highest standards in our industry, and we will strive to continually improve our business processes to provide our customers a level of service that consistently meets or exceeds expectations.

<b>Contents</b>	<b>Page</b>
<b>Aviation</b>	
Commercial Fiber Optic Termination Kit	5
Military and Commercial Fiber Optic Termination Kit	6
Elio Fiber Optic Termination Kit	7
FiberChek2 Inspection and Cleaning Kit	8
Epoxy Curing Ovens	9
Epoxy Curing Adapters	9
Epoxy and Adhesives	10
Preparation Tools	10-11
Installation Tools/Cleaning Tool	11
Cleaning Kits	12-13
Inspection Tools	13
Test Equipment	14-15
Reference Cables (AMQJs)	16
<b>Blown Optical Fiber (BOF)</b>	
Support Kit/Duct Testing Kit	17
Casualty Restoration Kit	18
Accessories	19-21
Fusion Splice Trays, Holder, and Protection Sleeves	21
<b>Ground Tactical (TFOCA®)</b>	
Universal Splice Kit	22
Termination/Fusion Splice Kit	22
Military/Commercial Termination Kit	23
Military/Commercial Inspection, Cleaning, and Test Kit	23
Inspection, Termination and Support Tools	24-26
Consumables	26-28
Pigtail Assemblies and Test Equipment	28
High Quality Jumpers (HQJ)	29
High Quality Launch Cables (HQLC)	29

<b>Contents</b>	<b>Page</b>
<b>Pierside Connectivity</b>	
Connectors/Dust Caps/Accessories	30
Umbilical Reel Assemblies	31
Termination and Upgrade Kits	32
LS/PM and MQJ Sets	33
Cleaning Kit	34
Consumables Kit	34
OTLS/MQJ Test Cable Kit	34
<b>Shipboard</b>	
Navy Submarine Kit (NAVSEA Drawing# 7085185)	35
Combination Kit	36
Multi Terminus Kit (NAVSEA Drawing# 6872813)	37
Single Terminus Kit (NAVSEA Drawing# 6872811)	38
Termination Kit Add-On Modules	39
Fusion Splice Backpack Kit	40
Fusion Splicer and Accessories	41
Inspection and Cleaning Kit	42
Curing Products	43
Inspection Tools	44-46
Termination Tools	47-48
M28876 Termination Tools	48-49
Rotary Mechanical Splice Tools	49-50
Preparation Tools	51-53
Safety Materials	53
Safety Kit	53
Polishing Tools/Plates/Pads	54
Polishing Films/Adhesives	55-56
Syringes and Needle Tips	56
Cleaning Products	56-58
NAVSEA Approve Consumables Kits	58
Consumables	58-60
Measurement Quality Jumpers	61-63
Measurement Quality Jumper Test Set	64
Testing Equipment	65-66
MQJ Connectors	67-71
M29504/14 and M29504/15 Termini	72
Mil-Spec ST Connectors and Adapters, and Dust Caps	73
Navy Approved COTS ST Connectors and Adapters	73
COTS Termini and Crimp Sleeves	74
Navy Approved COTS SC and LC Connectors	74
COTS SC and LC Adapters	75
WidgCo Feedthru Strain Relief (WFSR)	75
<b>Services and Training</b>	
Technical Services	76
Training	76

- KITCO Fiber Optics is ISO 9001:2005 and AS9100D certified and attests to the quality of products listed in the catalog. We have made every effort to ensure that the information is accurate. However, we accept no responsibility for any errors or omissions, and we reserve the right to modify design, characteristics at any time without obligation.
- Product images are not to scale.



TFOCA II® is a trademark of Amphenol Fiber Systems International

Call 1.757.518.8100 or visit [www.kitcofiberoptics.com](http://www.kitcofiberoptics.com) 1151 Azalea Garden Road, Norfolk, VA 23502 - Fax 1.757.518.9700

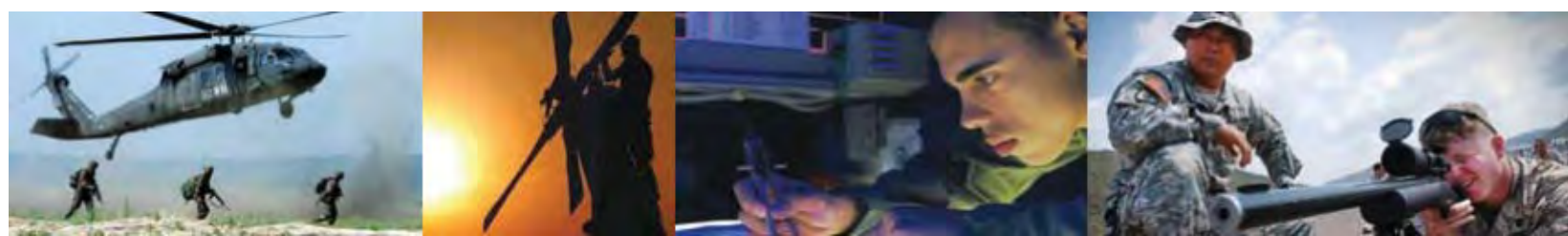

***KITCO Fiber Optics is a leading provider of fiber optic connectorization products and consulting services to the military and commercial communications industry. We are recognized within the defense industry as fiber optic connectivity experts, and for more than 20 years have customized our products and services to meet strict military standards.***

***We are proud to announce that we are now AS9100: D Certified!***



### ***Tools and Tool Kits***

- Shipboard MIL-C-83522/16 and MIL-PRF-28876 Connector; MIL-PRF-29504/14 and MIL-PRF-29504/15 Termini
- Aviation MIL-DTL-38999 Connector, MIL-PRF-29504/04 and MIL-PRF-29504/05 Termini
- TFOCA II® Connector Termination and Fusion Splicer Kits
- Pierside Connectivity, MIL-PRF-28876 and MIL-83522/16 Connector
- BLOLITE® Shipboard Blown Optical Fiber



### ***Training***

- Certified NAVSEA Military/Shipboard
- Certified Aviation Training
- TFOCA II® Ground Tactical Fiber
- Pierside Connectivity
- Certified BLOLITE® (BOF) Training Course
- ETA FOI/FOT Certification Training
- NAVSEA Certified Cableway Training
- NAVSEA Certified Circular Copper Connector Training



### ***Technical Services***

- Termination of BOF/Conventional MIL-PRF-85045 Cables
- Termination of M28876, M83522/16, M29504
- Termination of M38999 and M29504/04/05
- Testing and Troubleshooting
- Certification/License for BOF
- System Repair
- INSURV Inspections

### ***Custom Cable Assemblies***

- Measurement Quality Jumpers (MQJs)
- Aerospace Measurement Quality Jumpers (AMQJs)
- MIL-PRF-28876 Connector; TFOCA II®, Hermaphroditic, ST, FC, SC, LC, MIL-DTL-38999
- MIL-STD-2042C



***KITCO's Virginia Beach location is AS9100D /ISO 9001:2015 Certified***

Call 1.757.518.8100 or visit [www.kitcofiberoptics.com](http://www.kitcofiberoptics.com) 1151 Azalea Garden Road, Norfolk, VA 23502 - Fax 1.757.518.9700

# Aviation Termination Kits



## Commercial Aviation Fiber Optic Termination Kit Part# 0741-8000

The 0741-8000 Aviation Termination Kit is a multi-purpose kit designed to accommodate commercial air transport fiber optic connectors. This kit can be configured to work with specific aircraft platforms, and contains the single temperature (90° C) epoxy curing oven.

This kit will allow the technician to terminate and install the following connectors/termini:

- ARINC 801 Termini
- EN-4531 (ARINC 801) Termini
- M29504/04 Pin Termini, 1.6mm
- M29504/05 Socket Termini, 1.6mm
- ST Style Connectors
- SC Connectors
- LC Style Connectors
- ARINC 801 Circular Connectors
- ARINC 801 Rectangular Connectors
- M38999 Connectors



Call 1.757.518.8100 or visit [www.kitcofiberoptics.com](http://www.kitcofiberoptics.com) 1151 Azalea Garden Road, Norfolk, VA 23502 - Fax 1.757.518.9700

# Aviation Termination Kits



## Military and Commercial Aviation Fiber Optic Termination Kit Part# 0741-8001

The 0741-8001 Military and Commercial Aviation Fiber Optic Termination Kit is a multi-purpose kit designed to accommodate military and commercial fiber optic connectors. This fiber optic kit will terminate most fiber optic connectors found onboard the aircraft. The 0741-8001 kit contains our programmable epoxy curing oven that allows for a scheduled ramp cure profile. This kit can also be configured to work with specific aircraft platforms.

This kit will allow the technician to terminate and install the following connectors/termini:

- ARINC 801 Termini
- EN-4531 (Appendix C) Termini
- M29504/04 Pin Termini, 1.6mm
- M29504/05 Socket Termini, 1.6mm
- ST Style Connectors
- SC Connectors
- LC Style Connectors
- ARINC 801 Circular Connectors
- ARINC 801 Rectangular Connectors
- M38999 Connectors



# Aviation Termination Kits



## Elio Fiber Optic Termination Kit Part# 0741-8005

The 0741-8005 Elio Fiber Optic Termination Kit was designed with input from the Commercial Aviation Transport Industry. This fiber optic kit is designed to terminate the Souriau Elio terminus (EN 4531) for installation into circular and rectangular aerospace connectors.

This kit contains the following items:

- Programmable Oven
- Epo-Tek® 353ND Epoxy
- All required Polishing Films
- 2.50mm Carbide Tungsten Polishing Puck
- 200X Handheld Microscope
- All required termination tooling
- Insertion/Extraction Tools for the Elio Terminus



Call 1.757.518.8100 or visit [www.kitcofiberoptics.com](http://www.kitcofiberoptics.com) 1151 Azalea Garden Road, Norfolk, VA 23502 - Fax 1.757.518.9700

# Aviation Inspection and Cleaning Kit



## Fiber Optic FiberChek2 Inspection and Cleaning Kit

**Part# 0741-8010**

The 0741-8010 Aviation Fiber Optic Handheld Inspection and Cleaning Kit, which contains a VIAVI FBP-HD4i display and FBP-P5000i probe was designed with input from the Commercial Aviation Transport Industry. This fiber optic kit is designed to clean and inspect most common types of fiber optic connectors found onboard the aircraft.

This kit will allow the technician to inspect and clean the following connectors/termini:

- M38999 Connectors
- ARINC 801 Circular Connectors, 1.25mm
- ARINC 600 Rectangular Connectors, 1.25mm
- ARINC 801 Rectangular Connectors, 1.25mm
- Quadrax Size 8 Connectors
- ARINC 801 Termini, 1.25mm
- EN 4531 Termini
- M29504/04 Pin Termini, 1.6mm
- M29504/05 Socket Termini, 1.6mm
- ST/SC/LC Connectors



Call 1.757.518.8100 or visit [www.kitcofiberoptics.com](http://www.kitcofiberoptics.com) 1151 Azalea Garden Road, Norfolk, VA 23502 - Fax 1.757.518.9700



# Aviation Epoxy Curing Ovens

## 16-Port Dual Epoxy Oven

**Part# 0700-9140**

This epoxy oven comes with two 8-port heater blocks and is perfect for heat curing epoxies. It is factory set at 90°C for proper curing.



## Preform Reflow Oven

**Part# 0741-1110**

The 0741-1110 reflow oven was designed specifically for reflowing preform epoxy. The oven is used primarily for the stainless steel ruby jeweled M29504/04, 1.6mm, and M29504/05, 1.6mm, termini.



## Programmable Curing Oven Assembly

**Part# 0721-1305**

KITCO Fiber Optics designed this oven to allow soaking time and temperature selection for various industry epoxies. The SAE standard recommends curing fiber optic connectors in a programmable oven when building outside of a pressure bulkhead (i.e. - The build is subject to the temperature and pressure changes of an aerial platform during flight.) Ramping of the epoxy will result in a more robust cure for such an environment.

The assembly contains the following:

- Programmable Oven
- Oven Heater Block
- 1.6mm Cure Adapters for M29504/04 and M29504/05 Termini
- Cable Stand Post
- Cable Stand Ring
- Cable Clamps

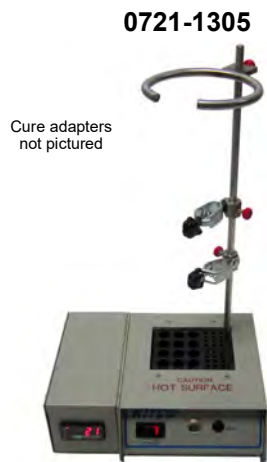

# Epoxy Curing Adapters

**M29504/04 and M29504/05  
ARINC 801 Cure Adapter  
ST Cure Adapter**

**NSN# 5935-01-591-3829  
NSN# 5935-01-646-6508  
NSN# 6070-01-420-0551**

**Part# 0721-1125  
Part# 0700-1456  
Part# 0700-1450**

0721-1125



0700-1456



0700-1450



## Aviation Epoxy and Adhesives

0700-5020

### Threadlocker Adhesive **NSN# 8030-01-055-6126** **Part# 0700-5020**

The 0700-5020 adhesive is specifically used to secure the M29504/05 socket metal alignment sleeve to the termini after polishing of the endface is completed. If this step is not performed, the alignment sleeve will unscrew while inserting and removing the terminus from the M38999 connector.



### Fast Cure Epoxy **Part# 0700-5510**

NAVAIR NA01-505-4 manual recommends the technician apply this fast cure epoxy to the base of the Kevlar<sup>®</sup>, thus preventing "wicking" of the epoxy from the rear of the M29504/04, 1.6mm, and M29504/05, 1.6mm, termini and under the outer jacket.

0700-5510



### Epo-Tek<sup>®</sup> 353ND Epoxy **Part# 0700-5520**

This is a two-component, room temperature curing epoxy adhesive. The system will cure at temperatures as low as -18° C (0° F) and has a convenient mix ratio, and excellent cohesive strength.

0700-5520



## Aviation Preparation Tools

### Epoxy Mixing Dish **Part# 3300-6005**

Mixing dishes are a clean convenient way to mix otherwise messy epoxies, specifically for application with our 0700-5120, Front Injection Tool,

3300-6005



### Stainless Steel Polishing Puck **Part# 0721-1530** **NSN# 5120-01-588-2945**

This polishing puck will allow the technician to polish 1.6mm termini, M29504/04 pin and M29504/05 socket .



### Epoxy Pipette Front Injection Tool for ARINC 801/Luxcis Termini **Part# 0700-5120**

This adjustable pipette is used to inject a precise amount of epoxy into the tip of the ARINC 801 termini ferrule. The ARINC 801 termini requires injecting the epoxy from the front, as rear injection will lock up the internal spring and render the termini useless. This front injection tool comes with 25 pistons and capillaries. Replacement boxes of 50 pistons and 50 capillaries are available.

0700-5120



### Pistons and capillaries (50 of each per box) **Part# 0700-5122**

0700-5122



### Scriber Pick Tool **Part# 0700-3340**

This pick tool is adapted to segregate the individual strands of aramid yarn when terminating loose structured fiber.

0700-3340



## Aviation Preparation Tools

### Cable Clamp

**Part# 0721-1123**

**0721-1123**

This tool was adapted from the medical community to be used as a quick and convenient alternative to the Hardman Double/Bubble® in securing an unterminated fiber in the stripping process.



## Aviation Installation Tools

### Insertion/Extraction Tools

Use to insert and extract rear release M29504/04, 1.6mm, and M29504/05, 1.6mm, Souriau Elio (EN4531), and the ARINC 801 termini. These tools have either plastic or metal tips.

- |  |                              |
|--|------------------------------|
| <b>M29504/04 and M29504/05, ARINC 801 Insertion Tool (metal)</b>     | <b>Part# 0721-1120</b>       |
| <b>M29504/04 and M29504/05, ARINC 801 Ins/Ext Tool (metal)</b>       | <b>Part# 0721-1121</b>       |
| <b>Souriau Elio Ins/Ext Tool (plastic)</b>                           | <b>Part# 0721-1124</b>       |
| <b>M29504/04 and M29504/05, ARINC 801 Extraction Tool (metal)</b>    | <b>Part# 0721-1130</b>       |
| <b>M29504/04 and M29504/05, ARINC 801 Ins/Ext Tool (plastic)</b>     | <b>Part# 0721-1140</b>       |
| <b>M29504/04 and M29504/05, Termini Assist Removal Tool (Delrin)</b> | <b>Part# 0721-1150</b>       |
|  | <b>NSN# 5120-01-578-3510</b> |

The 0721-1150 Termini Assist Removal Tool is specifically designed to assist the technician extracting a termini by gently pushing the pin or socket termini from the front up over the internal locking ring while using the extraction tool which greatly reduces stress created at the point between the termini and the cable assembly.

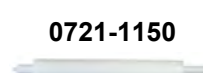

## Aviation Cleaning Tool

KITCO has designed a cleaning tool to be used exclusively on the F-35 Joint Strike Fighter Platform. This long reach tool is needed to clean MTP connectors located in the back of the chassis of the aircraft.

### MTP Cleaning Tool w/Lanyard Replacement MTP Adapter Cap w/Lanyard Assembly

**Part# 0700-5381**  
**Part# 0700-5455**

**0700-5381**



**0700-5455**



Call 1.757.518.8100 or visit [www.kitcofiberoptics.com](http://www.kitcofiberoptics.com) 1151 Azalea Garden Road, Norfolk, VA 23502 - Fax 1.757.518.9700

# Aviation Cleaning Kits

KITCO's fiber optic cleaning kits are designed to clean many styles of termini and connectors. Choose from five different kits depending on which connector/termini you are cleaning.

- Master Cleaning Kit for 2.50mm, 2.00mm, 1.60mm, and 1.25mm ferrule** Part# 0741-6000
- Cleaning Kit for 2.50mm ferrule** Part# 0741-6001
- Cleaning Kit for 2.00mm ferrule** Part# 0741-6002
- Cleaning Kit for 1.60mm ferrule** Part# 0741-6003
- Cleaning Kit for 1.25mm ferrule** Part# 0741-6004



*Always CLEAN (and inspect) before you CONNECT!!*



# Aviation Inspection Tools

## Video Display w/Probe

**Part# FBP-SD4i**

Viavi's FBP-SD4i SmartClass™ Video Inspection Kit integrates fiber inspection and test into an efficient solution that promotes fiber-handling best practices and gives technicians flexibility and performance in one easy-to-use device.

Key features are:

- 3.5" touch screen display (FBP-HD4i)
- 200/400x Video Probe (FBP-P5000i)
- Store all fiber inspection and test results on board
- Easily generate fiber certification reports
- Automated pass/fail analysis for fiber inspection and test
- Tips include: Universal 1.25 and 2.5mm, SC, LC



The following tips to be used with our FBP-SD4i, 0700-8640 Backplane Video Inspection Kit, 0700-8625 Video Probe, 0741-8010 Aviation Fiber Optic Inspection and Cleaning Kit and 0741-8015 Fiber Optic Inspection and Cleaning Kit:

- Viavi M29504/14 (pin) Video Probe Tip
- Viavi M29504/15 (socket) Video Probe Tip
- Viavi ST Bulkhead Video Probe Tip
- Viavi SC Bulkhead Video Probe Tip
- Viavi LC Bulkhead Video Probe Tip
- Viavi Universal 1.25mm Patch Cord Video Probe Tip
- Viavi Universal 2.50mm Patch Cord Video Probe Tip
- Viavi M29504/04, 1.6mm (pin) Video Probe Tip
- Viavi M29504/05, 1.6mm (socket) Video Probe Tip
- Viavi Quadrax (pin) Video Probe Tip
- Viavi Quadrax (socket) Video Probe Tip
- Viavi Standard Barrel Assembly Video Probe Adapter
- Viavi Narrow Barrel Assembly Video Probe Adapter

- Part# 0700-8644
- Part# 0700-8645
- Part# 0700-8646
- Part# 0700-8647
- Part# 0700-8655
- Part# 0700-8656
- Part# 0700-8657
- Part# 0700-8659
- Part# 0700-8660
- Part# 0700-8672
- Part# 0700-8673
- Part# FBPP-BAP1
- Part# FBPP-BAP3

0700-8644



0700-8645



0700-8646



0700-8647



0700-8655



0700-8656



0700-8657



0700-8659



0700-8660



0700-8672



0700-8673



FBPP-BAP1



FBPP-BAP3



**Always INSPECT (and clean) before you CONNECT!!**





## Quad Optical Power Meter

**Part# 0705-5520**

The 0705-5520 optical power meter is a rugged, high quality, general-purpose instrument suitable for many fiber optic measurement applications. Paired with LED or laser sources, this optical power meter is ideal for insertion loss testing of multimode and singlemode fiber optic connectors. This power meter can be also used for link loss testing of uninstalled cable harnesses. The 0705-5520 simplifies output power measurements of transmitters and other light sources. The four calibrated wavelengths, indium-gallium-arsenide (InGaAs) photo detector, and wide dynamic range make it suitable for measuring the output of both LED and laser based transmitters. In addition, a broad range of Snap-On Connector (SOC) adapters for both industry standard fiber optic connectors and many less common types, makes this power meter an indispensable tool for aerospace technicians. An ST adapter comes stand with this meter. SOC adapters available separately.



## Dual LED Source

**Part# 0705-5522**

Paired with the 0705-5520 optical power meter, the 0705-5522 is a LED source for testing the insertion loss of multimode fiber and connectors. With output at 850 /1310nm, this source is used with an optical power meter for dual wavelength link loss testing of installed cable plants. The 0705-5522 can be fitted with precision ST, FC or SC connector adapters which ensure maximum accuracy and repeatability when performing critical measurements on fiber optic systems. An ST adapter comes stand with this source. When ordering, please specify desired connector type. Call KITCO for more details.



## Dual Laser Source

**Part# 0705-5512**

Paired with the 0705-5520 laser source the 0705-5512 facilitates certification of aircraft harnesses and installed fiber optic links. The 0705-5512 provides dual 1310/1550µm output for fiber applications. This source can be fitted with precision ST, FC or SC connector adapters which ensure maximum accuracy and repeatability when performing critical measurements on fiber optic systems. An ST adapter comes stand with this source. When ordering, please specify desired connector type. Call KITCO for more details.



## Light/Laser Source and Power Meter Adapters

ST Adapter for Light/Laser Source

**Part# 0705-5563**

ST Adapter for Power Meter

**Part# 0705-5564**

SC Adapter for Light/Laser Source

**Part# 0705-5561**

SC Adapter for Power Meter

**Part# 0705-5562**

LC Adapter for Light/Laser Source

**Part# 0705-5567**

LC Adapter for Power Meter

**Part# 0705-5568**



# Military Aviation Test Equipment Compliant w/MIL-STD-461E



## Quad Optical Power Meter w/EMI Shielding **Part# 0705-5525**

The 0705-5525 optical power meter is an easy to use, rugged, high quality, general-purpose instrument suitable for military use as the enhanced EMI performance complies with MIL-STD-461E, Method RS103 and tested to 190 V/m. Paired with LED or laser sources, this optical power meter is ideal for insertion loss testing of multimode and singlemode fiber optic connectors. This power meter can be also used for link loss testing of uninstalled cable harnesses. The 0705-5525 simplifies output power measurements of transmitters and other light sources. The four calibrated wavelengths, 1mm indium-gallium-arsenide (InGaAs) photo detector and wide range dynamic wavelengths make it suitable for measuring the output of both LED and laser based transmitters. In addition, a broad range of Snap-On Connector (SOC) adapters for both industry standard fiber optic connectors and many less common types, makes this power meter an indispensable tool for aerospace technicians. An ST adapter comes stand with this meter. SOC adapters available separately.



## Dual LED Source w/EMI Shielding **Part# 0705-5535**

Paired with the 0705-5525 optical power meter, the 0705-5535 is designed for military use as the enhanced EMI performance complies with MIL-STD-461E, Method RS103 and tested to 200 V/m. With output at 850nm and 1300nm, this source is used with an optical power meter for dual wavelength link loss testing of installed cable plants. The 0705-5535 is fitted with precision ST, FC or SC connector adapters which ensure maximum accuracy and repeatability when performing critical measurements on fiber optic systems. An ST adapter comes stand with this source. When ordering, please specify desired connector type. Call KITCO for more details.



## Dual Laser Source w/EMI Shielding **Part# 0705-5545**

Paired with the 0705-5525 optical power meter, the 0705-5545 is designed for military use as the enhanced EMI performance complies with MIL-STD-461E, Method RS103 and tested to 200 V/m and facilitates certification of aircraft harnesses and installed fiber optic links. The 0705-5545 provides dual 1310nm and 1550nm output with SAE AS062 launch profile for fiber applications per SAE aerospace standard ARP5061. This source is fitted with precision ST, FC or SC connector adapters which ensure maximum accuracy and repeatability when performing critical measurements on fiber optic systems. An ST adapter comes stand with this source. When ordering, please specify desired connector type. Call KITCO for more details.



## Light/Laser Source and Power Meter Adapters

ST Adapter for Power Meter

**Part# 0705-5560**

ST Adapter for Laser/Light Source

**Part# 0705-5530**

SC Adapter for Power Meter

**Part# 0705-5566**

SC Adapter for Laser/Light Source

**Part# 0705-5599**



Call 1.757.518.8100 or visit [www.kitcofiberoptics.com](http://www.kitcofiberoptics.com) 1151 Azalea Garden Road, Norfolk, VA 23502 - Fax 1.757.518.9700

# Aerospace Measurement Quality Jumpers



KITCO Fiber Optics now offers a solution for testing fiber optic cable harnesses utilizing the MIL-DTL-38999 connectors and rectangular connectors. Until now, reliable Aerospace Measurement Quality Jumpers (AMQJ), or reference cables, were not available to test aerospace fiber optic cables. KITCO's AMQJs are designed to duplicate the mating forces of two mated aerospace fiber optic cables, just as they would be installed on the aircraft platform.

KITCO's multi-channel AMQJs utilize a universal key to allow testing of any keying configurations that may be encountered. Our AMQJs are available in both the standard plug connectors with M29504/04, 1.6mm, pin and standard receptacle connectors with M29504/05, 1.6mm, socket termini. KITCO can also manufacture the plug connectors with socket inserts and receptacle connectors with pin inserts. Another design feature allows us to repair and/or replace individual strands, thereby eliminating a total replacement of the AMQJ and saving time and money.

The table below lists KITCO's standard AMQJ configurations. KITCO Fiber Optics specializes in developing and manufacturing custom AMQJs for most types of aerospace connectors, and we can work with you to develop the correct type of AMQJ for any platform application. **Please call us for additional details!**

KITCO Part#	Item Description*	Length
KFO 11196	M29504/04 Termini to ST, Tight Buffered, 62.5/125µm, multimode	1 meter
KFO 11197	M29504/05 Ruby Jeweled to ST, Tight Buffered, 100/140µm, multimode	1 meter
KFO 70000-M01	ARINC 801 Termini to ST, Tight Buffered, 62.5/125µm, multimode	1 meter
KFO 70000-M02	ARINC 801 Termini to ST, Tight Buffered, 62.5/125µm, multimode	2 meters
KFO 70001-M01	ARINC 801 to ST, Loose Structure, 62.5/125µm, multimode	1 meter
KFO 70001-M02	ARINC 801 Termini to ST, Loose Structure, 62.5/125µm, multimode	2 meters
KFO 70002-M01	M29504/04 Termini to ST, Loose Structure, 62.5/125µm, multimode	1 meter
KFO 70003-M01	M29504/05 Termini to ST, Loose Structure, 62.5/125µm, multimode	1 meter
KFO 70004-M01	ST to ST, Loose Structure, 62.5/125µm, multimode	1 meter
KFO 70004-M02	ST to ST, Loose Structure, 62.5/125µm, multimode	2 meters
KFO 70005	ST to ST, Loose Structure, 100/140µm, multimode	1 meter
KFO 70006	M29504/04 Ruby Jeweled to ST, Loose Structure, 100/140µm, multimode	1 meter
KFO 70007	M29504/05 Ruby Jeweled to ST, Loose Structure, 100/140µm, multimode	1 meter
KFO 70008	ST to LC, 62.5/125µm, Loose Structure, multimode	1 meter
KFO 70010	2-Channel Plug w/Sockets to ST, Tight Buffered, 62.5/125µm, multimode	1 meter
KFO 70011	2-Channel Receptacle w/Pins to ST, Tight Buffered, 62.5/125µm, multimode	1 meter
KFO 70013	2-Channel Receptacle to ST, Tight Buffered, 62.5/125µm, multimode	1 meter
KFO 70014	4-Channel Plug w/Sockets to ST, Tight Buffered, 62.5/125µm, multimode	1 meter
KFO 70016	4-Channel Plug to ST, Tight Buffered, 62.5/125µm, multimode	1 meter
KFO 70017	4-Channel Receptacle to ST, Tight Buffered, 62.5/125µm, multimode	1 meter
KFO 70018	ARINC 801 Termini to ST, 8.3/125µm, Loose Structure, singlemode	1 meter
KFO 70019	ST to ST, 8.3/125µm, Loose Structure, singlemode	1 meter
KFO 70021	5-Channel Receptacle w/Pins to ST, Tight Buffered, 62.5/125µm, multimode	1 meter
KFO 70025	2-Channel Receptacle to ST, N-Keyed, Tight Buffered, 50/125µm, multimode	2 meters
KFO 70026	2-Channel Plug w/Sockets to ST, Tight Buffered, 50/125µm, N-Keyed, multimode	2 meters
KFO 70027	2-Channel Receptacle to ST, A-Keyed, Tight Buffered, 50/125µm, multimode	2 meters
KFO 70032	ST-M29504/05 Termini to ST, Tight Buffered, 50/125µm, multimode	2 meters
KFO 70033	M29504/04 Termini to ST, Tight Buffered, 50/125µm	1 meter
KFO 70040	2-Channel ARINC 801 Plug to ST, Tight Buffered, 62.5/125µm, multimode	1 meter
KFO 70041	2-Channel ARINC 801 Receptacle to ST, Tight Buffered, 62.5/125µm, multimode	1 meter
KFO 70042	4-Channel ARINC Plug to ST, Tight Buffered, 62.5/125µm, multimode	1 meter
KFO 70043	4-Channel ARINC Receptacle to ST, Tight Buffered, 62.5/125µm, multimode	1 meter
KFO 70060	ARINC 801 Termini w/Quadrax socket adapter to ST, Tight Buffered, 62.5/125µm, multimode	2 meters
KFO 70070	5-Channel Plug, Ruby Jeweled to ST, Loose Structure, 100/140µm, multimode	1 meter
KFO 70071	5-Channel Receptacle, Ruby Jeweled to ST, Loose Structure, 100/140µm, multimode	1 meter
KFO 70072	5-Channel Plug w/Sockets, Ruby Jeweled to ST, Loose Structure, 100/140µm, multimode	1 meter
KFO 70073	5-Channel Receptacle w/Pins, Ruby Jeweled to ST, Loose Structure, 100/140µm, multimode	1 meter
KFO 71015	4-Channel Receptacle w/Pins to ST, Tight Buffered, 50/125µm, multimode	1 meter
KFO 71017	4-Channel Receptacle to ST, Tight Buffered, 50/125µm, multimode	1 meter
KFO 71020	4-Channel Receptacle w/Pins to ST, Tight Buffered, 62.5/125µm, multimode	1 meter

**NOTE: Not all connector types are listed. Any of the above part numbers can be customized to meet your specific interface and length requirements, please call for details.**

**\*Unless otherwise noted, all multichannel receptacle assemblies come standard with sockets and all multichannel plug assemblies come standard with pins.**





## Blown Optical Fiber Kits

### BLOLITE® Support Kit for Shipboard Blown Optical Fiber

**Part# 0745-1010**

BLOLITE® is a trademark of Brand-Rex Ltd. And used under license

The 0745-1010 Shipboard BLOLITE® Support Kit contains all the tools needed to support the actual blowing of shipboard blown optical fiber. This kit enables the installer to switch out inlet guides, as well as test the Microduct. Specialty wrenches, sign-off sheets, cleaning wires, tube cutters, duct test head, and a new and improved SpadeLok™ Duct Connector Tool is included in this support kit. All tools are protected in a rugged, custom carrying case.

**This kit contains the following items:**

- Adjustable Wrench
- Tube Cutters (5mm and 8mm)
- Jacket Strip Tool
- Side Cutters
- Safety Glasses
- Hex Wrenches (3 mm and 5mm)
- Duct Test Head
- 8mm Blowing Output Connector
- End Duct Trap
- Flexible Air Hose

..and many more



### BLOLITE® Duct Testing Kit for Shipboard Blown Optical Fiber

**Part# 0745-1020**

BLOLITE® is a trademark of Brand-Rex Ltd. And used under license

The 0745-1020 Duct Testing Kit contains all the tools needed to set up the new Air Supply Conditioning Unit and to test the pressurized duct for leaks and blockage. Wrenches, tube cutters, duct test head, projectiles, remote end duct connectors and all support tools for 8mm and 5mm are included. All tools are protected in a rugged custom carrying case.

**This kit contains the following items:**

- Adjustable Wrench
- Sign Off Sheets
- Side Cutters
- Tube Cutters (5mm and 8mm)
- Duct Test Head
- End Duct Trap
- Flexible Air Hose
- Blowing Output Connectors (5mm and 8mm)
- Projectiles (2.5mm and 4.5mm)
- ACU Blowing Hose Head
- Spadelok Duct Connector Tool

..and many more



Call 1.757.518.8100 or visit [www.kitcofiberoptics.com](http://www.kitcofiberoptics.com) 1151 Azalea Garden Road, Norfolk, VA 23502 - Fax 1.757.518.9700

## Blown Optical Fiber Kits

### Casualty Restoration Kit Navy Shipboard Fiber Optic Kit (Emergency Repair Kit for 8mm, 7 Tube Shipboard Multiduct, Blown Optical Fiber) **Part# 0701-8000 NAVSEA Drawing# 7344573** **NSN# 6080-01-659-2034**

The 0701-8000 Shipboard Casualty Restoration Kit is designed to enable the installer to quickly restore a completely severed section of BOF (Blown Optical Fiber). Eight (8) 100 foot jumpers of low smoke, zero halogen duplex shipboard COTS (Commercial off the Shelf) jumpers are included in the Shipboard Casualty Restoration Kit. These jumpers have M83522 ST connectors pre-installed on both ends to allow the technician to simply "plug and play." In a case where Blown Optical Fibers have been severed this kit includes 2 furcation units and all tools necessary to install these units to prepare the blown fiber for connectorization. Light Crimp Plus connectors and coupling adapters are also included as well as all appropriate connectorization tools. A rugged custom carrying case with shoulder strap protects all components and tools.

This kit contains the following items:

- LightCrimp Plus Tools
  - 100 ft LSZH Duplex Singlemode Jumpers
  - 100 ft LSZH Duplex Multimode Jumpers
  - 8-Channel Furcation Unit
  - LightCrimp Plus Connectors
  - Headband Light
  - Visual Fault Locator (VFL)
  - Safety Glasses
- ... and many more



# Blown Optical Fiber Accessories

## Straight Tube Coupler

This coupler features locking collars to prevent accidental disconnection and is installed onto 8mm Microduct tubing.

8mm **NSN# 6060-01-528-0633**  
5mm

**Part# 0745-2350**  
**Part# 0745-2340**

0745-2350



0745-2340



8mm T Coupler **NSN# 6060-01-552-8215** **Part# 0745-2352**

This coupler also features locking collars to prevent accidental disconnection and is used to check the pressure when blowing the optical fiber. Maximum operating pressure is 10 bar (g) or 145 psi.

8mm - 5mm Reducer **Part# 0745-2355**

It is necessary, when transitioning from 8-millimeter to 5-millimeter tubing to perform fiber blowing operations prior to attaching 5-millimeter tubing to blow paths. The 5-millimeter tube is used only to permit transition for improved routing and immediate termination inside the splice tray. This transition shall take place in protective enclosures (FOICB).

0745-2352



0745-2355



## Tube End Plug

Tube End Plugs fit securely into the 8mm Duct Connector to prevent contamination after Microduct are installed.

8mm **NSN# 4730-01-561-4180**

**Part# 0745-2335**

0745-2335



SpadeLok™ 5mm/8mm Duct Coupling Tool **Part# 0745-2280**

The 0745-2280 SpadeLok™ Duct Connector Tool is a precision tool designed for locking and removing the Duct Connectors onto the BLOLITE® Microduct. By wedging the SpadeLok™ between the housing of the connector and the collet, the installer guarantees that the connector is tight and secure. To remove the Duct Connector, simply turn the tool around and use it to push the collet in to release the Microduct.

0745-2280



## Blowing Output Adapter

Blowing Output Adapters allows the installer to interface between the Duct Test Head and the Microduct.

5mm Blowing Output Adapter  
8mm Blowing Output Adapter  
**NSN# 6060-01-652-8391**

**Part# 0745-2110**  
**Part# 0745-2120**

0745-2110



0745-2120



Duct Test Head **Part# 0745-2100**

The 0745-2100 Duct Test Head interfaces between the Air Supply Conditioning Unit and the Microduct. Shut-off valves allow the installer to control the flow of air and a pressure gauge allows the installer to monitor the pressure being applied. This requires the Blowing Output Adapter, 0745-2120.

0745-2100



Remote End Duct Projectile Trap, 8mm **Part# 0745-2135**

This device attaches to the far end of the Microduct. A shut-off valve stops the flow of air to allow the installer to pressure test the duct. When the valve is opened, a fiber optic projectile can be blown through the Microduct to check for a blockage. A removable reservoir safely catches the projectile.

0745-2135



# Blown Optical Fiber Accessories

## Tube Cutters/Jacket Slitter

The BOF Tube Cutters are specially designed to cut the Microduct at a 90° angle, which is necessary for duct connector installation. BOF Tube Cutters are available for 5mm and 8mm cable.

**5mm Tube Cutter**

**Part# 0745-2300**

**8mm Tube Cutter**

**Part# 0745-2310**

**Replacement Blades for 0745-2300 and 0745-2310**

**Part# 0745-2320**

**5mm and 8mm Tube Cutter**

**Part# 0745-2315**

**Replacement Blades for 0745-2315**

**Part# 0745-2319**

Our 0745-1245 Jacket Slitter is design to slit the jacket for the 7-way BOF tubing, M85045/25-01E.

## Jacket Slitter 1.0" - 1.4"

**Part# 0745-1245**

0745-2300



0745-2310



0745-2315



0745-1245



## Air Blown Test Valve Assembly

**Part# 0745-2155**

KITCO's Air Blown Test Valve Assembly is composed of an 8mm, ten inch long, clear tube with an air valve on one end. Simply install the Microduct "tee" coupling and attach the Microduct Air Gauge, 0745-2145, to the air valve to check the Microducts' internal air pressure.

0745-2155



## Microduct Digital Air Gauge

**Part# 0745-2145**

KITCO's digital air gauge simplifies testing air blown Microduct. Our gauge reads up to 160 psi in increments of 0.50 psi. Used with our 0745-2155 Air Blown Test Valve Assembly, testing air blown microducts is a breeze.

0745-2145



## \*Sealant Tape NSN# 5970-01-286-7457

**Part# 0700-5065**

This tape is used to seal around the optical fibers inside the tapered tube plug.

*\*This tape is packaged in a 300" roll however is it sold in 1" x 1/16" thick pieces.*

0700-5065



## Tapered Tube Plugs

Tapered tube plugs are used to hold the optical fibers in place when attaching furcation units to the blown fiber microduct.

0745-2325

**8mm Tapered Tube Plug**

**Part# 0745-2325**

**5mm Tapered Tube Plug**

**Part# 0745-2324**



0745-2324



## Inlet Guides

Used as the entry point to the blow-head, the purpose is to provide a transition from the fiber reels and guide the fibers onto the tractor belts where they are pushed into the pressure chamber before being routed into the cable microducts. The inlet guides come in sizes ranging from 4 to 12 ports.

0745-2180



0745-2190

**4-Fiber Inlet Guide**

**Part# 0745-2180**

**8-Fiber Inlet Guide**

**Part# 0745-2190**

**12-Fiber Inlet Guide**

**Part# 0745-2195**

0745-2195



# Blown Optical Fiber Accessories

## Duct Testing Projectiles

These projectiles are used to ensure BOF tubes are clear and free of any obstructions. The 4.5mm projectile is used for the initial test and the 2.5mm projectile is used to clear the 4.5mm projectile if it is stuck inside the BOF tube.

**4.5mm Projectile (100 per pkg)**  
**2.50mm Projectile (100 per pkg)**

**Part# 0745-2160**  
**Part# 0745-2165**



## Blown Optical Fiber Furcation Units

KITCO Fiber Optics manufactures U.S. Navy Shipboard approved furcation units. These units consist of low smoke, zero halogen 2.4mm furcation tubing that surrounds Kevlar® and a 650mm (ID), 900mm (OD) hollow tube. One end of the unit is strain relieved with polyethylene tubing, shrink tubing and an aggressive epoxy. An 8mm BOF (Blown Optic Fiber) tube is also epoxied inside the shrinkable tubing to allow the installer to couple the furcation unit with the existing duct work. After sliding the 500mm Blown Optical Fiber down the hollow tube, the installer can utilize the Kevlar® and jacket to properly connectorize shipboard ST and/or SC connectors in accordance with MIL-STD-2042C. Immediately available in a 4 fiber, 2 meter configuration, 8 fiber, 2 meter and 3 meter configurations, and 12 fiber 1.8 meter configuration  
**Limited configurations available upon request.**

**4 fiber, 2 meter**      **NSN# 6080-01-525-1214**  
**8 fiber, 2 meter**      **NSN# 6080-01-525-1216**  
**8 fiber, 3 meter**  
**12 fiber, 1.8 meter**

**Part# 0705-8120**  
**Part# 0705-8130**  
**Part# 0705-8130-M03**  
**Part# 0705-8140**

**0705-8120**



**0705-8130**



# Fusion Splice Trays, Holders and Protection Sleeves

## Splice Tray w/Aluminum Cover NSN: 6080-01-578-9832

**Part# 0732-1106**  
**NAVSEA Approved**

KITCO's Fiber Splice trays are designed to provide complete protection for delicate stripped fibers and splices for all types of fiber cable configurations and are designed to meet MIL-I-24728/8A specifications. The aluminum trays are five inches wide to provide enhanced fiber managements and are offered with a snap-on cover. Crimp tabs and tie-down holes make it easy to secure all types of fiber and fiber sub-units. The trays also feature mounting thru-holes for installation into enclosures and higher density stacking.

**0732-1106**



## Splice Sleeve Holders (1 pair) NSN: 6625-01-689-2800

**Part# 0732-1113**  
**NAVSEA Approved**

KITCO's Splice Sleeve Holders are designed to accommodate our standard fusion splice protection sleeves. These flexible and high quality silicone rubber devices can accommodate up to 12 splice sleeves and come with a high-peel strength 3M™ brand adhesive for easy application to almost any surface. Engineered to eliminate the concerns of water absorption, these holders may also be used for securing a variety of other types of fiber optic devices, such as splitters and mechanical splices.

**0732-1113**



## Standard Series Fusion Splice Protection Sleeves (40mm)

**Part# 0703-3775**  
**NAVSEA Approved**

KITCO's "Standard Size" fusion splice protection sleeve is designed to provide a robust performance and meet all MIL-PRF-24623/6A specifications. These sleeves have an after shrink diameter of 2.9mm and will accommodate fiber diameters up to 1.4mm. The splice protection sleeves are constructed with an inner EVA (Ethylene-Vinyl Acetate) meltable adhesive tube; stainless steel strength member and a polyolefin heat shrink outer tube.

**0703-3775**



**\*\*Sleeves are sold individually**



Call 1.757.518.8100 or visit [www.kitcofiberoptics.com](http://www.kitcofiberoptics.com) 1151 Azalea Garden Road, Norfolk, VA 23502 - Fax 1.757.518.9700

# Ground Tactical Military/Commercial Fusion Splice Kit



## Quad Universal Splice Kit

**Part# 0831-1119**

The 0831-1119 is a Universal, Fusion Splice Kit. The splicer is designed to splice single, dual, or even all four TFOCA II® fibers simultaneously. This feature demonstrates a tremendous cost savings by allowing the technician to splice any fiber configuration using "pigtailed". Systems may be made functional in a matter of moments - even in battlefield environments.

This kit contains the following items:

- Quad Fusion Splicer
- Tweezers
- Wrenches
- Pliers
- Ruler
- Dual Splice Protection Sleeves
- Quad Splice Protection Sleeves
- Visual Fault Locator (VFL)
- Torx Driver
- Stripping Tools
- Kevlar Shears

## TFOCA II® Termination/Fusion Splice Kit

**Part# 0831-8230**

**NSN# 5180-01-503-8251**

The 0831-8230 is a Combination Termination/Fusion Splice Kit. This kit will terminate the following connector types:

- TFOCA II® Connectors: AFSI, AOS, Delphi, Glenair, QPC, STRAN Technologies
- M83522/16 ST Connectors
- SC Connectors
- LC Connectors

This kit contains the following items:

- Quad Fusion Splicer
- Termination Tools
- Fusion Splice Sleeves
- Military Oven
- Consumables
- Inspection Tools



...and many more!



Call 1.757.518.8100 or visit [www.kitcofiberoptics.com](http://www.kitcofiberoptics.com) 1151 Azalea Garden Road, Norfolk, VA 23502 - Fax 1.757.518.9700

## Ground Tactical Military/Commercial Fiber Optic Tool Kit

### TFOCA II® Military/Commercial Fiber Optic Termination Kit

**Part# 0831-8235**

**NSN# 5180-01-574-5828**

The 0831-8235 is a Universal Connector Kit that will allow the Warfighter to replace or repair any style of ST, SC, LC or TFOCA II® connector they may encounter. A unique dual purpose oven, special universal crimping tool with interchangeable dies, and all other materials to maintain any connector found in theater are included.

This kit contains the following items:

- Templates
- Cure Adapters
- Polishing Tools
- Crimp Tool
- Crimp Tool Dies
- Consumables (Polishing Paper, Epoxy, Syringes w/Needle Tips, Wipes)
- Kevlar Shears
- Stripping Tools
- Primer/Adhesive
- Epoxy
- Microscope
- Hot Melt and Epoxy Curing Oven
- Safety Mat
- Safety Glasses

... and much more



## Ground Tactical Military/Commercial Inspection, Cleaning and Test Platform Kit

### Ground Tactical Military/Commercial – Inspection, Cleaning, and Test Platform Kit

**Part# 0831-8245**

**NSN# 5180-01-574-5887**

The 0831-8245 Inspection, Cleaning and Test Platform Kit contains a fully functional and portable OTDR (Optical Time Domain Reflectometer) that allows the Warfighter to immediately find excessive bends or breaks in any fiber optic link. A Quad Light Source for LED and LASER wavelengths is included as well as all necessary HQJs (High Quality Jumpers). Inspection Probe tips are included to allow inspection of endfaces of multiple termini (TFOCA II®), first and second generation connectors without disassembling them. All cleaning supplies such as swabs, wipes and fiber optic cleaning fluid are also included in this kit.

This kit contains the following items:

- OTDR
- Light Source
- Power Meter
- Video Probe
- Probe Tips
- Cleaning Supplies
- HQRCs for Light Source/Power Meter
- HQLCs for OTDR
- Couplings



Call 1.757.518.8100 or visit [www.kitcofiberoptics.com](http://www.kitcofiberoptics.com) 1151 Azalea Garden Road, Norfolk, VA 23502 - Fax 1.757.518.9700

## Ground Tactical Inspection Equipment

### Fiber Inspection Probe System

**Part# 0700-8222**

Using a Fiber Inspection Probe to ensure that connectors/adapters are clean and exempt of any defect is where accurate testing starts. With the 0700-8222 Fiber Inspection Probe System, the Warfighter can check connectors and other fiber terminations for polish quality and cleanliness. Benefit from the best optical resolution in the industry and see scratches and dirt particles as small as 1µm. The probe also uses a USB converter to send image captures to a portable platform or a PC.



- Handheld Display w/7" screen
- Dual 200x/400x Magnification Probe
- Rechargeable Battery and Power Supply
- Universal 1.25 and 2.5mm Patchcord Tip, LC and SC Tip
- Soft Carrying Case

## Ground Tactical Termination Tools

### Corning Pretium® Cleaver w/Diamond Blade Corning Pretium® Installation Tool

**Part# 0703-3740**

**Part# 0703-3745**

The 0703-3740 Cleaver is a companion product to the Corning 0703-3745 Pretium® Unicam® Installation Tool. The Corning Pretium® ST, SC, and LC style connectors are usually referred to as No Epoxy, No Polish (NENP) products.

These connectors are set with epoxy and "factory polished" which results in extremely low dB loss. An index matching gel material is also injected into these connectors so when the Warfighter cleaves and inserts the 90° angled fiber into the connector (utilizing the Pretium® Installation Tool) the connection is automatically completed. The Pretium® Installation Tool has a built-in Visual Fault Locator (VFL) that instantly verifies a successful connector installation. The Warfighter no longer has to wait for an oven to heat up or bother with mixing messy epoxy. An average connector can be completed from start to finish in well under 5 minutes

0703-3740



0703-3745



## Ground Tactical Termini

The TFOCA II™ termini are designed to meet MIL-DTL-83526/16 (DRAFT) specifications. Built around a 2.5mm zirconia ferrule, these termini are genderless and offer singlemode or multimode performance.

0204-7105



## Ground Tactical Support Tools

### TFOCA II® Spanner Wrench NSN# 5120-01-564-3558

**Part# 0700-4620**

The 0700-4620 TFOCA II® Spanner Wrench is used to insert and remove the insert nut from the TFOCA II® connector receptacle.

0700-4620





# Ground Tactical Support Tools

## TFOCA II® Spring Compression Insertion and Removal Tool (SCIRT)

**Part# 0731-1132**

**NSN# 5120-01-564-3546**

The 0731-1132 Spring Compression Install and Removal Tool (SCIRT) is used to insert and remove the termini from the retaining plate for TFOCA II® connectors.

0731-1132



## TFOCA II® Plate Insertion and Removal Tool (PIRT)

**NSN# 5120-01-564-3562**

**Part# 0700-4625**

The 0700-4625 Plate Insertion and Removal Tool (PIRT) is used to insert and remove the insert from the TFOCA II® connector receptacle.

0700-4625



## TFOCA II® Flare Nut Wrench

**NSN# 5120-01-428-8291**

**Part# 0700-4610**

The 0700-4610 Flare Nut Wrench is used to remove the strength member wedge pack from the strain relief housing inside the TFOCA II® connector.

0700-4610



## Lanyard Crimp Sleeve Tool

**NSN# 5120-00-170-7938**

**Part# 0731-1160**

The 0731-1160 Lanyard Crimp Sleeve Tool is used to crimp the lanyard crimp sleeve onto the lanyard for the TFOCA II® dust cap.

0731-1160



## TFOCA Splice Enclosure (JPS-400)

**NSN# 6070-01-527-2509**

**Part# 0731-1170**

The 0731-1170 TFOCA II® TFOCA Splice Enclosure (JPS-400) was designed by KITCO Fiber Optics and the U.S. Marine Corps to allow the Warfighter to properly protect the M85045 Tactical Fiber Optic Cable after it has been spliced. This extremely rugged yet completely flexible jacket protection sleeve assumes the contour of the diameter of the fiber reel.

The JPS-400 can be easily disassembled and reused if a mistake is made during the initial protection process or if rework is required, making this splice protector perfect for the battlefield environment.

This product should be used in conjunction with the 0831-1119 Splice Kit.

0731-1170



Call 1.757.518.8100 or visit [www.kitcofiberoptics.com](http://www.kitcofiberoptics.com) 1151 Azalea Garden Road, Norfolk, VA 23502 - Fax 1.757.518.9700

## Ground Tactical Support Tools

### TFOCA II® Splice Enclosure Nut Wrench **Part# 0731-1210** **NSN# 1240-01-540-3763**

The 0731-1210 TFOCA II® Splice Enclosure Nut Wrench allows the end cap to thread completely onto the connection fitting on the TFOCA II® Jacket Protection Sleeve (JPS-400).



### TFOCA II® Jacket Strip Tool **Part# 0700-3055** **NSN# 5110-01-564-3559**

The 0700-3055 Jacket Strip Tool was designed from input by the Warfighters to enable them to easily strip and remove the outer jacket of the M85045/8A TFOCA II® ruggedized cable. Two opposing razor-sharp blades sink just deep enough to split the tough jacket without damaging the buffer, tangling the Kevlar, or harming the fiber.



### Dual Hot Melt Epoxy Oven w/Automatic Shutdown **Part# 0700-9151** **NSN# 7310-01-646-2784**

The 0700-9151 Dual Hot Melt Epoxy Oven was specifically designed for the U.S. Marines. The oven has a shut off feature that will turn off the oven after two hours. The oven has a warning indicator light built into the cover to warn the Warfighter that the oven chassis is too hot to touch or to put the oven into the termination kit. The oven also features indicator lights to let the Warfighter know which oven section is turned on.



## Ground Tactical Consumables

### Fusion Splice Sleeves

These fusion splice sleeves are designed specifically to work with TFOCA® style cables, both two and four channel. The dual fusion splice sleeve will allow the Warfighter to protect TFOCA® style cables (2 channel) using just one dual splice sleeve. The quad fusion splice sleeve will allow the Warfighter to protect TFOCA TFOCA II® style cables (four channel) using just one quad splice sleeve.

- Dual Fusion Splice Sleeves (25 per pack)** **NSN# 5940-01-540-3857** **Part# 0731-1186**
- Dual Fusion Splice Sleeves (48 per pack)** **NSN# 6060-01-527-2497** **Part# 0731-1187**
- Quad Fusion Splice Sleeve (25 per pack)** **Part# 0731-1188**



### Lanyard Crimp Sleeves **Part# 0204-5060** **NSN# 4030-01-562-0478**

The 0204-5060 Lanyard Crimp Sleeves are used to attach the wire lanyard for the TFOCA II® dust cap to the body of the TFOCA II® connector.

0204-5060



### Threadlocker Adhesive **Part# 0700-5020** **NSN# 8030-01-055-6126**

Use the 0700-5020 Threadlocker Adhesive to lock the threads of the backnut for TFOCA II® connectors.

0700-5020



Call 1.757.518.8100 or visit [www.kitcofiberoptics.com](http://www.kitcofiberoptics.com) 1151 Azalea Garden Road, Norfolk, VA 23502 - Fax 1.757.518.9700

# Ground Tactical Consumables

## Super Lube® NSN# 9150-01-562-0513

Super Lube® is a trademark of Super Lube

Use the 0700-5420 Super Lube to lubricate the O-Ring on both TFOCA II® termini and the TFOCA II® connectors.

Part# 0700-5420

0700-5420



## Instant Adhesive NSN# 8040-01-216-7508

Use the 0700-5045 Instant Adhesive to secure the TFOCA II® Tygon tubing to the fiber optic buffer to allow the termini to stay properly seated while curing in the epoxy oven.

Part# 0700-5045

0700-5045



## Card Cleaner NSN# 6070-01-564-8364

The 0700-5370 Card Cleaner is used to clean the TFOCA II® termini endfaces and other COTS connectors.

Part# 0700-5370

0700-5370

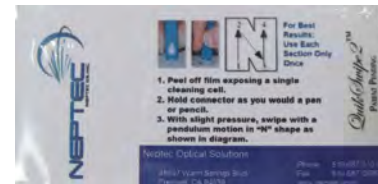

## Needle Tip 20AWG, 1.0” NSN# 5120-01-645-7417

Used with the 0700-5121 Syringes, the 0700-5144 Needle Tip is used for all other COTS connectors and TFOCA II® termini.

Part# 0700-5144

0700-5144



## TFOCA II® Consumables Kit NSN# 6080-01-527-6994

The 0831-9010 contains replenishment supplies for the consumables items found in KITCO Fiber Optics' Military/Commercial Termination Kits.

Part# 0831-9010

This kit contains the following items:

- Polishing Papers
- Epoxy
- Syringes w/Needle Tips
- Cleaning Wire
- Anaerobic Adhesive and Primer
- Fiber Optic Connector Cleaner Spray
- Lint Free Wipes
- Alcohol Pads
- Wooden Cleaning Swabs
- Permanent Marker



Call 1.757.518.8100 or visit [www.kitcofiberoptics.com](http://www.kitcofiberoptics.com) 1151 Azalea Garden Road, Norfolk, VA 23502 - Fax 1.757.518.9700

## Ground Tactical Consumables

### Monster Cleaning Kit

**Part# 0831-9050**

A master cleaning consumables kit, the 0831-9050 contains plenty of materials to allow the Warfighter easy access to replace cleaning materials.

This kit contains the following items:

- Cleaning Sticks
- Fiber Preparation Fluid
- Dry Wipes
- IBC™ Cleaning Tools



## Ground Tactical Pigtail Assemblies

### TFOCA II® Pigtail Cable Assembly Kit

**Part# 0831-3PTSG**

The 0831-3PTSG, TFOCA II®, Pigtail Cable Assembly Kit includes the JPS-400 Jacket Protection Sleeve and Dual Splice Sleeves. Using the 0831-1119 Fusion Splice Kit allows the Warfighter to quickly repair the TFOCA II® cable reels.



### MFOCA™ Pigtail Cable Assembly Kit

**Part# 0831-3PTM**

The 0831-3PTM MFOCA (Mixed Mode Fiber Optics/Expanded Beam) Pigtail Cable Assembly Kit includes the JPS-400 Jacket Protection Sleeve and Dual Splice Sleeves. Using the 0831-1119 Fusion Splice Kit allows the Warfighter to quickly repair the MFOCA (Mixed Mode Fiber Optics/Expanded Beam) cable reels.



## Ground Tactical Test Equipment

### TFOCA II® Optical Loss Test Set Kit

**Part# 0831-8240**

The #0831-8240 Optical Loss Test Set (OLTS) Kit is designed for testing the M83526/16, TFOCA II® cable reels for link loss. This kit comes with all the required High Quality Reference Cables (HQRCs) and an approved stabilized multimode Light Source and Power Meter for testing. The unit can be operated using battery or AC power.



# High Quality Jumper (HQJ) Matrix

Part Number	Description	Length (m)
<b><u>High Quality Launch Cables (HQLC)</u></b>		
KFO 80050	TFOCA II® Termini to ST, 62.5/125µm multimode <b>NSN# 6020-01-602-1518</b>	15
KFO 80055	TFOCA II® Termini to ST, 9.0/125µm singlemode	18
KFO 80065	Expanded Beam Hybrid to ST, 50µm Multimode/9.0µm singlemode <b>NSN# 6020-01-602-1514</b>	18
KFO 80071	ST to ST, 62.5/125µm multimode <b>NSN# 6020-01-602-1515</b>	15
KFO 80072	ST to SC, 62.5/125µm multimode <b>NSN# 6020-01-602-1516</b>	15
KFO 80073	ST to LC, 62.5/125µm multimode <b>NSN# 6020-01-602-1517</b>	18
KFO 80075	ST to ST, 9.0/125µm singlemode <b>NSN# 6020-01-602-1519</b>	18
KFO 80076	ST to SC, 9.0/125µm singlemode <b>NSN# 6020-01-602-1520</b>	18
KFO 80077	ST to LC, 9.0/125µm singlemode <b>NSN# 6020-01-602-1521</b>	18
KFO 80095	TFOCA II® Plug to ST, 62.5/125µm multimode	15
KFO 80097	TFOCA II® Plug to ST, 9.0/125m singlemode	18
<b><u>High Quality Reference Cables (HQRC)</u></b>		
KFO 80040	TFOCA II® Plug to ST, 62.5/125µm multimode <b>NSN# 6020-01-602-1512</b>	1
KFO 80045	TFOCA II® Plug to ST, 9.0/125m singlemode	1
KFO 80060	Expanded Beam Hybrid to ST, 50µm Multimode/9.0µm singlemode <b>NSN# 6020-01-602-1513</b>	1
KFO 80070	ST to ST, 9.0/125µm singlemode	1
KFO 80080	ST to SC, 62.5/125µm multimode <b>NSN# 6020-01-602-1523</b>	1
KFO 80081	ST to LC, 62.5/125µm multimode <b>NSN# 6020-01-602-1522</b>	1
KFO 80082	ST to ST, 50/125µm multimode <b>NSN# 6020-01-602-1524</b>	1
KFO 80086	ST to SC, 9.0/125µm singlemode	1
KFO 80087	ST to LC, 9.0/125µm singlemode	1
KFO 80088	ST to ST, 62.5/125µm multimode <b>NSN# 6020-01-602-1525</b>	1

**HRLC** Launch Cable used with an Optical Time Domain Reflectometer (OTDR)  
**HQRC** Reference Cable used with a Optical Light Source (OLS) and Optical Power Meter (OPM)



Call 1.757.518.8100 or visit [www.kitcofiberoptics.com](http://www.kitcofiberoptics.com) 1151 Azalea Garden Road, Norfolk, VA 23502 - Fax 1.757.518.9700

## Pierside Connectivity Connectors

Aptiv's (formerly Delphi Connection Systems) hermaphroditic connectors provide superior, consistent optical performances when deployed in the harshest environments. The connectors allow concatenations of cable assemblies to extend equipment separation without concern for connector male/female interface compatibility. Additionally, these connectors have "blind mating" and "scoop proofing" features to provide easy-to-mate interconnects.

Hermaphroditic connectors are "genderless" and designed to allow intermating of "like connectors" used on cable assemblies. This is achieved by converting one of the cable plug connectors to a male connector configuration by backing off the coupling nut to expose its male threaded end and bringing the other connector's (female configuration) coupling nut forward to thread onto the exposed receptacle threads. This allows the cable assemblies to be deployed without concern for having a male or female connector at the end of the cable.

Another benefit of the hermaphroditic connector design is that it allows identical cable assemblies to be concatenated as many times as needed (to be limited only by the system's optical loss budget). This provides flexibility in the placement of the end terminals. A simple but unique wiring arrangement must be observed when cable concatenation is used.

### 12-Channel Receptacle

Part# 1123770H

1123770H



### 12-Channel Plug

Cable Diameter Range .50" - .63"  
 Cable Diameter Range .35" - .50"  
 Cable Diameter Range .28" - .47"

Part# 1123760H  
 Part# 1123760-1H  
 Part# 1123760-2H

1123760H



**\*For related termini and crimp sleeves, see pages 79 and 81**

## Pierside Connectivity Dust Caps

### 12-Channel Receptacle Dust Cap 12-Channel Plug Dust Cap

Part# 1143808-4H  
 Part# 1123789H

1143808-4H

1123789H



## Pierside Connectivity Accessories

### Removable 6-Pack Socket Endface

Part# 1123796H

1123796H

Aptiv's 12-Channel Hermaphroditic connector is equipped with a removable, self-captivating (non-removable alignment sleeves) socket endface. The endface allows the installer to easily replace the socket termini without the need of buying a completed connector.

**\*\*If the alignment sleeve is damaged, the entire 6-Pack must be replaced\*\***



### 12-Channel O'Ring Install Tool

Part# 0702-3500

Our 0702-3500 allows the technician to install the O'Ring onto the 12-Channel Hermaphroditic connector with ease; minimizing the risk of breakage.



Call 1.757.518.8100 or visit [www.kitcofiberoptics.com](http://www.kitcofiberoptics.com) 1151 Azalea Garden Road, Norfolk, VA 23502 - Fax 1.757.518.9700

# Pierside Connectivity Umbilical Reel Assembly

## Umbilical Assembly Wooden Spool

Part# KFO 11565

Built IAW NAVSEA Drawing 7325759, Rev D spec, this assembly is used to provide a fiber optic connection between the pier and the ship. This umbilical assembly consists of a 12-fiber, 500 foot cable with a hermaphroditic plug on each end. **Because this assembly is not made with low smoke/zero halogen fiber, it must be stored on the exterior of the ship or external to the ship. It is not suited for shipboard interior storage/use.**

## Alternative Umbilical Assembly Wooden Spool

Part# KFO 35847

Built as a substitute to NAVSEA same Drawing 7325759, Rev D spec, this assembly is made with flexible flame-retardant polyurethane outer jacket and low-smoke/zero halogen strands that are suitable for shipboard interior storage/use.

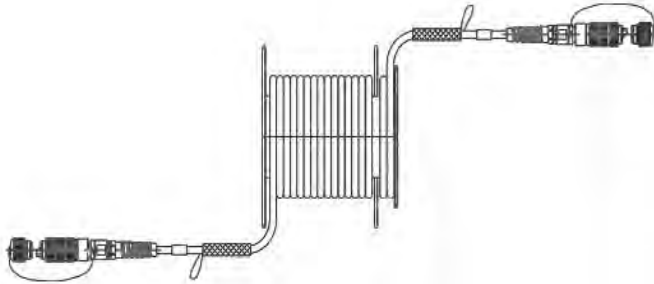

## Metal Umbilical Reel (empty)

Part# 0900-3010

Using the same flame-retardant polyurethane material as in KFO 35847, we now offer 2 options for the Pierside Umbilical Reels. They can be ordered on a composite reel with or without a stand.

## Umbilical Assembly w/Composite Reel and Metal Stand Umbilical Assembly w/Composite w/Reel, without Stand

Part# KFO 15847

Part# KFO 25847



## Composite Umbilical Reel (empty) Metal Umbilical Stand (empty)

Part# 0900-3025

Part# 0900-3028



Call 1.757.518.8100 or visit [www.kitcofiberoptics.com](http://www.kitcofiberoptics.com) 1151 Azalea Garden Road, Norfolk, VA 23502 - Fax 1.757.518.9700

# Pierside Connectivity Kits

## Pierside Connectivity Termination Kit (Light Duty Connector ST, COTS SC and M29504 Termini)

NAVSEA Drawing# 7325763

NSN# 5180-01-523-6083

Part# 4000-1010

The 4000-1010 Pierside Connectivity Termination Kit contains all the proper tools and consumables needed to connectorize the (M29504/14 and M29504/15) installed in the 12-channel Hermaphroditic connector, Single Terminus, (ST) M83522/16 Light Duty, and (SC) TIA 604-3 connectors onto the end of fiber optic, single fiber cable strands. A 70 durometer resilient pad, and polishing papers (5µm AO, 1µm AO, 0.1µm diamond) are included to allow the installer to accomplish a multimode or "enhanced" singlemode polish.

This kit contains the following items:

- Kevlar Shears
- Cleaning Wire
- Insertion Tools
- Removal Tool
- Alignment Sleeve Insertion and Removal Tool (ASIRT)
- Flashlight
- Curing Oven
- Microscope
- Polishing Tools
- Ruler
- Scribe
- Allen Wrench
- Boot Ring Tool
- Templates
- Marking Pen
- Tweezers

... and much more



This kit does not include the additional tools needed to affix the strain relief onto the 12-Channel Hermaphroditic plug. For tools that are needed to assemble the strain relief, please see our 4000-1015 Upgrade Kit listed below.

## Pierside Connectivity Upgrade Kit

Part# 4000-1015

The 4000-1015 Upgrade Kit, when used with the 0400-1010 kit, contains the additional tools needed to install a 12-channel backshell onto a hermaphroditic connector plug.

This kit contains the following items:

- Torque Wrench
- Allen Wrenches
- Socket Adapter
- O-Ring Installation Tool
- Crow's Foot Attachments
- Template



Call 1.757.518.8100 or visit [www.kitcofiberoptics.com](http://www.kitcofiberoptics.com) 1151 Azalea Garden Road, Norfolk, VA 23502 - Fax 1.757.518.9700



# Pierside Connectivity Kits

## Pierside Connectivity Light Source/Power Meter Kit

**Part# 4000-1020 NAVSEA Drawing# 7325763**

This kit is to be used in conjunction with the MQJs (listed in MQJ Sets **KFO 10022, 4000-1060, and 4000-1065** below), to test cable links for loss. All appropriate adapter caps are included on each unit.

This kit contains the following items:

- Multimode LED Source
- Singlemode Laser Source
- Quad Power Meter



## ST to ST MQJ Set Containing SC to ST Adapters

**Part# KFO 10022 NAVSEA Drawing# 7325763**

MQJs (Measurement Quality Jumpers) must be used to test optical link loss. By interfacing the correct jumpers with a Light Source and Power Meter accurate loss measurements can be obtained.

This kit contains the following items:

- MQJ, ST-to-ST, multimode
- MQJ, ST-to-ST, singlemode enhanced
- ST-to-ST Adapter, singlemode
- SC-to-ST singlemode/multimode adapter



## Hermaphroditic Connector MQJ Set

**Part# 4000-1060 NAVSEA Drawing# 7325763**

MQJs (Measurement Quality Jumpers) must be used to test optical link loss. By interfacing the correct jumpers with a Light Source and Power Meter accurate loss measurements can be obtained.

This kit contains the following items:

- MQJ, 12-Channel Hermaphroditic Connector Cable Plug to ST , 1 Meter (Qty 2)

**\*4000-1060 is sold in a set of 2 however the single MQJ, KFO 11347-M01, is sold individually.**



## Hermaphroditic Connector Pigtail Assemblies

**NAVSEA Drawing# 7325760**

**Part# KFO 11347** This assembly is a 1.5 meter, 12-channel Hermaphroditic Receptacle to ST and is used inside the box on the pier to which the umbilical assembly hooks up.

**Part# KFO 15368** This assembly is a 1 meter, 12-channel Hermaphroditic Receptacle to ST and is used inside the box on the pier to which the umbilical assembly hooks up.



## ST to Termini MQJ Set Singlemode Enhanced and Multimode

**Part# 4000-1065 NAVSEA Drawing# 7325763**

This kit contains the following items:

- Singlemode Enhanced and Multimode Single Strand MQJs
- Snap Lock Plugs
- Snap Lock Receptacles
- Insertion/Extraction/ASIRT Tools
- Termini Alignment Sleeves



# Pierside Connectivity Kits

## Cleaning Kit

**Part# 4000-1030** NAVSEA Drawing# 7325763

This Cleaning Kit consists of the tools necessary to clean the 12-Channel Hermaphroditic connector.

This kit contains the following items:

- Solvent
- Canned Air
- Lint Free Wipes
- Eye Loupe
- Allen Wrench
- Alcohol Pads
- Swabs
- Custom Case



## Consumables Kit

**Part# 4000-1050** NAVSEA Drawing# 7325763

This Consumables Kit has enough polishing paper, epoxy, syringes, tips, and wipes to terminate 100 ST Connectors or Termini.

This kit contains the following items:

- Epoxy
- Polishing Papers
- Syringes
- Needle Tips
- Lint Free Wipes



## OLTS/MQJ Test Cable Kit

**Part# 4000-1025** NAVSEA Drawing# 7325763

The OLTS/MQJ Test Cable Kit contains all the necessary reference and cables tools needed to test single and multi-channel, multimode or singlemode cables.

This kit contains the following items:

- Hard Carrying Case (not pictured)
- ST-ST MQJ Set
- Hermaphroditic MQJ Set
- ST-Termini - MQJ Set
- Termini Insertion/Removal Tools
- Coupling Adapters
- Snap Lock Plugs and Receptacles
- Replacement Alignment Sleeves



# Shipboard Termination Kits



## Combination Fiber Optic Kit (Light Duty Connector, Heavy Duty Multiple Termini)

**Part# 0801-8030**    **NAVSEA Drawing# 7085185**  
**NSN#: 5180-01-494-7433**

The 0801-8030 Combination Fiber Optic Kit contains all the proper tools and consumables that are needed to connectorize the M83522/16 (ST), Light Duty, Single Terminus Connector, and M28876 (MT), Heavy Duty, M29504, Multiple Termini Connectors. This tool kit also supports the 31 channel M28876 connector (singlemode and multimode), as well as the TIA 604-3 (SC) Connector. A 70 durometer resilient pad, 0.1µm diamond paper, and ultrafine final polishing papers are included to allow the installer to accomplish a multimode or singlemode "enhanced" polish.

This kit contains the following items:

- Torque Wrench
- Torque Wrench Adapters
- Insertion Tools
- Extraction Tool
- ASIRT (Alignment Sleeve Insertion/Removal Tool)
- Microscope
- Curing Oven
- Cure Adapters
- O-Ring Adapters
- Polishing Papers
- Epoxy
- Needle Tips/Syringes
- Crimp Tool
- Crimp Tool Dies
- Polishing Tools
- Microclips
- Safety Glasses
- Jacket/Buffer Strippers
- Tweezers

... and many more



This kit now contains tools to terminate  
the LC connector!!



Call 1.757.518.8100 or visit [www.kitcofiberoptics.com](http://www.kitcofiberoptics.com) 1151 Azalea Garden Road, Norfolk, VA 23502 - Fax 1.757.518.9700

# Shipboard Termination Kits



## Combination Kit Navy Shipboard Fiber Optic Kit, Deluxe Contractor's Version (Light Duty Connector, Heavy Duty Multiple Termini) Part# 0701-7030

The 0701-7030 Combination Connector Kit contains all the proper tools and consumables that are needed to connectorize the M28876 (MT), Heavy Duty, Multiple Termini Connectors and the M83522/16 (ST), Light Duty, Single Terminus. This tool kit also supports the TIA 604-3 (SC) Connector. A 70 durometer resilient pad, 0.1µm diamond paper, and ultrafine final polishing papers are included to allow the installer to accomplish a multimode or singlemode "enhanced" polish.

**\*\*Please verify NAVSEA Drawing requirements before ordering this kit\*\***

This kit contains the following items:

- Torque Wrench
- Torque Wrench Adapters
- Insertion Tools
- Extraction Tool
- ASIRT (Alignment Sleeve Insertion/Removal Tool)
- Microscope
- Curing Oven
- Cure Adapters
- O-Ring Adapters
- Polishing Papers
- Epoxy
- Needle Tips/Syringes
- Crimp Tool
- Crimp Tool Dies
- Polishing Tools
- Microclips
- Safety Glasses
- Jacket/Buffer Strippers
- Tweezers

... and many more



This kit now contains tools to terminate the LC connector!!



Call 1.757.518.8100 or visit [www.kitcofiberoptics.com](http://www.kitcofiberoptics.com) 1151 Azalea Garden Road, Norfolk, VA 23502 - Fax 1.757.518.9700

## Shipboard Termination Kits



**MIL-PRF-28876 Multi Terminus Kit**  
**Part # 0801-8000 NAVSEA Drawing# 6872813**  
**NSN: 5180-01-416-0567**

The 0801-8000 MIL-C-28876 Multiple Termini Kit contains all the proper tools and consumables that are needed to connectorize the M28876 Heavy Duty Multiple Terminus connector. Tools and consumables are included to support connectorization of the M29504/14 and M29504/15 termini. A 70 durometer resilient pad and 0.1µm diamond paper are included to allow the installer to accomplish a multimode or "enhanced" singlemode polish. This deluxe contractor's version meets NAVSEA Drawing# 6872813 requirements, and also includes many other tools and components.

This kit contains the following items:

- Torque Wrench
- Torque Wrench Adapters
- Insertion Tool
- Extraction Tool
- ASIRT (Alignment Sleeve Insertion/Removal Tool)
- Microscope
- Curing Oven
- Cure Adapters
- O-Ring Adapters
- Polishing Papers
- Epoxy
- Needle Tips/Syringes
- Crimp Tool
- Crimp Tool Dies
- Polishing Tool
- Microclips
- Safety Glasses
- Jacket/Buffer Stripper
- Tweezers

... and many more



Call 1.757.518.8100 or visit [www.kitcofiberoptics.com](http://www.kitcofiberoptics.com) 1151 Azalea Garden Road, Norfolk, VA 23502 - Fax 1.757.518.9700

## Shipboard Termination Kits



### MIL-C-83522 Single Terminus Termination Kit

**Part# 0801-8010** NAVSEA Drawing# 6872811 Rev. D

**NSN: 5180-01-416-0565**

The 0801-8010 ST Termination Kit contains all the proper tools and consumables that are needed to connectorize the M83522/16 (ST), Light Duty Single Terminus. This tool kit also supports the TIA 604-3 (SC) Connector. A 70 durometer resilient pad and 0.10µm diamond paper are included to allow the installer to accomplish a multimode or "enhanced" singlemode polish.

#### This kit contains the following items:

- Microscope
- Curing Oven
- Cure Adapters
- Boot Ring Tool
- Ruler
- Kevlar Shears
- Polishing Papers
- Epoxy
- Dry Wipes
- Needle Tips/Syringes
- Crimp Tool
- Crimp Tool Dies
- Microclips
- Safety Glasses
- Jacket/Buffer Strippers
- Tweezers

... and many more



This kit now contains tools to terminate the LC connector!!

Full details of NAVSEA kits 6872811, 6872813 and 7085185 can be found at the following: <https://www.navsea.navy.mil/Home/Warfare-Centers/NSWC-Dahlgren/What-We-Do/Navy-Shipboard-Fiberoptics/Drawings/>



Call 1.757.518.8100 or visit [www.kitcofiberoptics.com](http://www.kitcofiberoptics.com) 1151 Azalea Garden Road, Norfolk, VA 23502 - Fax 1.757.518.9700

# Shipboard Add-on Modules

## Upgrade a NAVSEA Drawing# 6872811 Kit to a Combo Kit Part# 0801-8060

This Module allows the installer to upgrade an existing NAVSEA Drawing# 6872811 Kit to a combination kit that will support the light duty, ST (Single Termini) and MT (Multi Terminus) connectorization process. The tools are contained in a handy roll-up tool pouch.

This kit contains the following items:

- Torque Wrench
- Insertion Tools
- Alignment Sleeve Insertion and Removal Tool
- Removal Tool
- Tweezers
- Crimp Tool
- Polishing Tool
- Socket Wrench Adapter
- Backshell Wrench
- Torque Wrench Adapters
- O-Ring Installation Tools
- Cure Adapters
- Strap Wrench



## Upgrade a NAVSEA Drawing #6872813 Kit to a NAVSEA Drawing #6872813/#6872811 Kit Part# 0801-8065

The 0801-8065 Add-On Module contains all of the tools proprietary to ST connectorization, SC connectorization and singlemode polishing.

This kit contains the following items:

- Crimp Tool w/ Die Set
- SC-ST Coupler
- Strip Templates
- Cure Adapters
- Polishing Tool
- Boot Installation Tool
- ST/SC Templates



## TIA 604-3 (SC) Upgrade Kit Part# 0801-8080

The TIA (Telecommunications Industry Association) has accepted the SC (Subscriber Connector) as the standard for the telecommunications industry. Consequently, electronics with the SC interface often appear aboard naval vessels. The 0801-8080 SC Upgrade Kit allows the installer to upgrade the existing #6872811 or #6872813 Termination Kits to support the SC procedure as well as the ST (Single Terminus) or MT (Multiple Termini) connectors.

This kit contains the following items:

- Crimp Tool w/Die
- Cure Adapters
- ST-SC Adapter
- Strip Template
- Polishing Tool



# Shipboard Fusion Splice Backpack

Part# 0731-8010

KITCO proudly introduces a shipboard fusion Backpack Kit that is specifically designed to protect and transport all the tools and equipment necessary to splice Blown Optical Fiber (BOF), as well as standard shipboard fiber within the Fiber Optic Interconnection Box. An easy to attach Clutch Tray provides the technician a sturdy and convenient area to place the Fujikura (AFL) FSM-90S, Core Alignment Fusion Splicer, Cleaver, and other tools so hands-on operation of the entire process can take place. This splicer is one of the only fusion splicers to be approved by NAVSEA Systems Command (CID A-A-59799). The Backpack allows for easy set up and break down as the technician moves from job to job.

This kit contains the following items:

- Fusion Splicer w/Accessories
- Precision Cleaver
- WidgCo Clutch Tray
- Utility Belt
- Kevlar Shears
- Fusion Splice Sleeves
- FiberSure™ Strippers
- Cloth Measuring Tape
- 5mm and 8mm Tube Cutter
- VFL (Visual Fault Locator)
- Spadelock Tool
- Cable Ties
- Splice Trays
- 5mm-8mm Transition Kit
- 4-fiber and 8-fiber Furcation Units
- 5mm and 8mm Brass Eyelets

...and many more

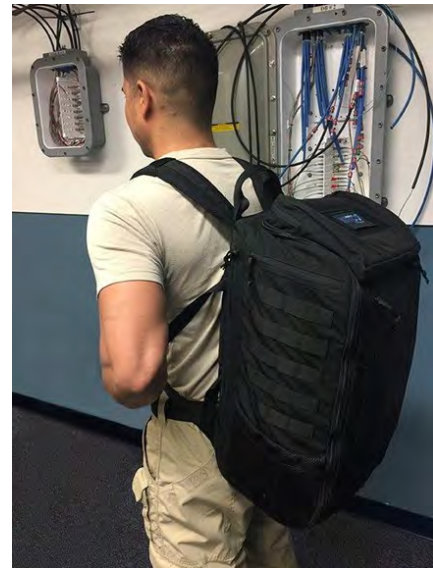
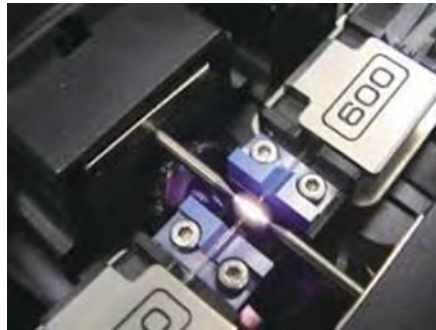

Call 1.757.518.8100 or visit [www.kitcofiberoptics.com](http://www.kitcofiberoptics.com) 1151 Azalea Garden Road, Norfolk, VA 23502 - Fax 1.757.518.9700



# Shipboard Fusion Splicer and Accessories

## Core Alignment Fusion Splicer

**Part# 0703-4030**

Featured in our new Shipboard Fusion Backpack Kit, 0731-8010, the AFL FSM-90S is the world's fastest and most robust core alignment fusion splicer and meets all the requirements in accordance to CID A-A-59799.

The FSM-90S is the latest core alignment splicer. It's designed to give you high quality splices and to stay in the field. The 90S kit solves common problems seen in the field today, from splicing poor quality legacy fiber to automated equipment maintenance and upkeep. The speed and accuracy of the 90S even make it suitable for certain production and specialty environments, where high output, tight packaging, and low loss requirements are needed. The 90S is designed to keep you going with an extended battery life of 300 splice and heat cycles, and by alleviating the need for traditional operation tasks such as; frequent arc calibrations, cleaver blade rotations, cleaver usage tracking, and manual splicing operations with its multiple automated and ease-of-use features. If you are splicing loose buffer fiber, there is no longer a need to purchase and swap out with an additional sheath clamp. Now, a universal sheath clamp that handles both loose and tight buffer fiber is standard.

**\*\* Please note that this configuration**



The FSM-90S comes standard with the following:

- Precision Cleaver
- Battery w/Charger
- AC Adapter w/Power Cord
- Spare Electrodes
- Sheath Clamp(s)
- Alcohol Dispenser
- Screwdriver
- Transit case
- Quick Reference Guide

## WidCo Clutch Tray

**Part# 0745-7010**

The Universal Clutch Tray is designed to safely and securely attach to any fiber optic interconnection box that houses the M24728 splice trays and holders. This tray affords the technician a convenient area to place the 90S fusion splicer, precision cleaver and other tools to simplify the fusion splice process.



## WidCo Shipboard Fusion Splice Backpack

**Part# 0745-2230**

The Shipboard Fusion Splice Backpack is a well-padded, sturdy, yet lightweight backpack designed to easily maneuver around the ship or submarine to complete fusion splicing with the fiber optic interconnection boxes and M24728 splice trays and holders. Every tool has a place, and every place has a tool for easy retrieval and transport.



## 8mm-5mm Transition Kit

**Part# 0732-1120**

Transitioning from an 8-millimeter to 5-millimeter tube is necessary to improve routing inside the fiber optic interconnection box. KITCO has designed a transition that contains all the materials need to perform this transition in accordance with MIL-STD-2042C, method 2L1.



Call 1.757.518.8100 or visit [www.kitcofiberoptics.com](http://www.kitcofiberoptics.com) 1151 Azalea Garden Road, Norfolk, VA 23502 - Fax 1.757.518.9700

# Inspection and Cleaning Kit

## Fiber Optic Handheld Inspection and Cleaning Kit

**Part# 0700-8634**

The 0700-8634 Fiber Optic Handheld Cleaning and Inspection Kit features the EXFO MAX Tester with ConnectorMax2 Software and the FIP-430B probe needed to inspect the fiber end-face for contamination. The fiber optic kit includes, lint free wipes, alcohol pads, STICK-LERS™ cleaning sticks and an ASIRT (Alignment Sleeve Insertion and Removal Tool) which allows the technician to remove the alignment sleeves from the termini before cleaning/inspecting.

The 0700-8634 comes in a water-resistant hard case.

This kit will allow the technician to inspect and clean the following connectors/termini:

- M28876 Connectors
- M29504/14 and M29504/15 Termini
- ST Connectors
- SC Connectors
- LC Connectors



The FIP-430B is an intelligent and automated test tool that transforms fiber inspection into a faster and simplified one-step process providing accurate and consistent test results, and preventing the reporting of false-positive results.

The key features are:

- Fully automated, one-step process: Automatic fiber-connection detection, Automatic image centering, Automatic focus
- On-board connector endface analysis (IEC, IPC or custom standards) via ConnectorMax2 Software
- Pass/fail LED indicator



**Always INSPECT (and clean) before you CONNECT!!**



Call 1.757.518.8100 or visit [www.kitcofiberoptics.com](http://www.kitcofiberoptics.com) 1151 Azalea Garden Road, Norfolk, VA 23502 - Fax 1.757.518.9700

# Curing Products

## Curing Oven Assembly

**Part# 0701-4000**

KITCO Fiber Optics was tasked by NAVSEA Combat Systems in 1992 to produce an oven that would allow the shipboard installer to accomplish a vertical cure for the MIL-C-83522/16 Light Duty ST Connector, the M29504/14 and M29504/15 Heavy Duty Termini and the COTS FDDI Connector. A higher curing temperature of 248° Fahrenheit assures a higher glass transition temperature needed for high vibration and harsh shipboard environments. A special heater block accepts termini when in one position and when flipped over the same heater block accepts ST, SC, and/or FDDI Connectors. A solid post, a ring and cable clips allow the installer to precisely position the fiber into the block for a straight, vertical cure. Special side panels are affixed to the oven housing to hold the 16 termini cure adapters, 0701-4050, that come with this assembly. See below for replacement parts.



0701-4000

- Curing Oven
- Heater Block
- Cable Stand Post
- Cable Stand Ring
- Cable Stand Clip

- NSN# 4430-01-419-6384
- NSN# 6070-01-420-7682
- NSN# 6070-01-430-4607
- NSN# 5365-01-420-3692
- NSN# 5430-01-422-2168

- Part# 0701-4010
- Part# 0701-4020
- Part# 0701-4030
- Part# 0701-4040
- Part# 0701-4060

0701-4010



0701-4040



0701-4060



0701-4030



0701-4020



## Cure Adapters

Cure adapters protect the connector and fiber during the epoxy cure process. **The ST and SC adapters are NAVSEA listed and approved for MIL-STD-2042C applications and will work only with KITCO's approved shipboard oven.**

- LC Cure Adapter
- ST Cure Adapter **NSN: 6070-01-420-0551**
- SC Cure Adapter **NSN: 6060-01-478-9450**
- Universal 2.50mm Cure Adapter **NSN: 5935-01-646-6514**
- Universal 1.25mm Cure Adapter **NSN: 5935-01-646-6508**
- M29504/14 and /15 Termini Cure Adapter **NSN: 6070-01-420-0522**

- Part# 0700-1430
- Part# 0700-1450
- Part# 0700-1455
- Part# 0700-1470
- Part# 0700-1456
- Part# 0701-4050

0700-1430



0700-1450



0700-1455



0700-1456



0700-1470



0701-4050



0300-4500



**Micro Clip** **NSN: 5340-01-534-2682**

**Part# 0300-4500**

Use the 0300-4500 Micro Clip to hold connector pieces in place during the curing process.



Call 1.757.518.8100 or visit [www.kitcofiberoptics.com](http://www.kitcofiberoptics.com) 1151 Azalea Garden Road, Norfolk, VA 23502 - Fax 1.757.518.9700

## Backplane Video Fiber Inspection Probe Kit **Part# 0700-8640**

KITCO's Backplane Video Fiber Inspection Probe Kit contains a portable, handheld microscope and the appropriate probe tips to inspect installed connectors located within patch panels, eliminating the need to access the backside of the patch panel. This kit will also allow an installer to inspect MQJs (Measurement Quality Jumpers) or any M28876 cable assemblies without disassembling them; the alignment sleeve in the socket (receptacle side) does not need to be removed to view the endface. All products are packaged in a customized hard shelled case for protection, convenience and portability.

This display and probe can be sold separately as part number FBP-SD4i. See page 13 for details.

### This kit contains the following:

- Video Probe (200x/400x)
- Handheld LCD Video Display w/Power Supply
- LC Probe Tip
- ST Probe Tip
- SC Probe Tip
- Universal 2.5mm Probe Tip
- Universal 1.25mm Probe Tip
- M28876 Pin Tip (for viewing pin endface)
- M28876 Socket Tip (for viewing socket endface)



## Benchtop 200X/400X Microscope

**Part# 0700-8626**

Simply plug the connector into the universal "slip-grip" adapter and the monitor will display the ferrule endface at a crystal clear 200X or 400X (about the size of a tennis ball)! This microscope allows the installer to quickly examine ferrule endfaces to detect epoxy residue, cracks, scratches and other irregularities in either the core or cladding glass.

The 0700-8626 comes standard with an 2.5mm universal adapter.

**See page 53 for a list of additional adapters.**

**0700-8626**



## FiberChek2™ Probe w/Software

**Part# 0700-8625**

The 0700-8625 is a digital handheld microscope that automatically inspects and certifies the end faces of fiber connectors according to industry standards and specifications. This digital microscope provides instant pass/fail results at the push of a button, eliminating subjective and time-consuming guesswork.

Compatible with multiple platforms, including T-BERD 2000/4000/6000A, laptops, PCs and Android mobile devices, the 0700-8625 provides fast, repeatable analysis that easily integrates into existing test procedures.

The 0700-8625 comes standard with 2.5mm, 1.25mm, LC, and SC/FC tips.

**See page 13 for a list of additional tips.**

**0700-8625**



# Inspection Tools

## Videoscope 200X/400X

**Part# TK-FIP-430B-6M1**

Enabled by its unique automatic focus-adjustment system, the TK-FIP-430B-6M1 automates each operation in the tests sequence, transforming the critical inspection step into a quick and simple on-step accessible process, providing accurate and consistent results, and preventing the reporting of false-positive results for technicians of any skill level.

The key features are:

- Fully automated, one-step process: Automatic fiber-connection detection, Automatic image centering, Automatic focus
- Prevents image capture in the even of improper focus alignment, This ensures that no performance-affecting defects or residues are ignored in the analysis.
- On-board connector endface analysis (IEC, IPC or custom standards) via Connector / Max2 Software
- Pass/fail LED indicator

The TK-FIP-430B-6M1 comes standard with 2.5mm, 1.25mm, LC, FC/SC, ST Bulkhead, M29504/14 and M29504/15 tip.



## Video Probe Tips

Interchangeable precision inspection tips enable inspection of every connector type located in bulkheads, patch cords, and multi-terminus connectors.

The following tips are to be used with our 0700-8634 Cleaning and Inspection Kit and TK-FIP-430B-6M1 Fiber Inspection Probe Kit:

- EXFO Barrel Adapter to Allow the use of JDSU Video Tips
- EXFO 1.25mm Universal Video Probe Tip
- EXFO 2.50mm Universal Video Probe Tip
- EXFO ST Bulkhead Video Probe Tip
- EXFO FC/SC Bulkhead Video Probe Tip
- EXFO LC Bulkhead Video Probe Tip
- EXFO 2.00mm Pin Video Probe Tip
- EXFO 2.00mm Socket Video Probe Tip
- EXFO 1.60mm Pin Video Probe Tip

- Part# 0700-8223
- Part# 0700-8226
- Part# 0700-8227
- Part# 0700-8228
- Part# 0700-8229
- Part# 0700-8230
- Part# 0700-8231
- Part# 0700-8232
- Part# 0700-8233

- 0700-8223
- 0700-8226
- 0700-8227
- 0700-8228
- 0700-8229
- 0700-8230
- 0700-8231
- 0700-8232
- 0700-8233



## 400X Microscope NSN: 6080-01-536-7147

**Part# 0700-8601**

This 400X scope is ruggedized and made of tempered steel. The 0700-8601 has a built-in infrared filter, is NAVSEA listed and approved for MIL-STD-2042C applications and come with a universal 2.5mm adapter (0700-8720) which is perfect for viewing the ST, SC, or FC connector.

See page 53 for a list of additional adapters.



## Dual 200X Microscope NSN: 6035-01-542-1931

**Part# 0700-7950**

This microscope provides dual-illumination, both coaxial and oblique, views. The coaxial illumination provides the most critical view of the fiber endface while the oblique illumination causes the light to hit the fiber endface at an angle, making the core clearly visible for an easy and ready view of surface debris and contamination. Universal 1.25mm, SC, and FC connector adapters and LC, ST bulkhead adapters are available. This microscope come with a universal 2.5mm adapter.

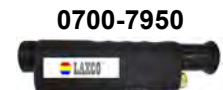

# Inspection Tools

## 400X Microscope Adapters

Coupling Adapter - Allows you to use 400X adapters w/200X microscope	NSN: 6650-01-586-5006	Part# 0700-7980
Universal 1.25mm Adapter	NSN: 6060-01-643-9065	Part# 0700-8722
ST Adapter	NSN: 6060-01-643-9080	Part# 0700-8723
SC Adapter	NSN: 6060-01-643-9072	Part# 0700-8724
FC Adapter	NSN: 6060-01-643-9072	Part# 0700-8725
LC Adapter	NSN: 6060-01-643-9207	Part# 0700-8731
M29504/4 and M2904/5 Adapter	NSN: 6650-01-865-5010	Part# 0700-8735
M29504/14 and M2904/15 Adapter		Part# 0700-8736



## Fibersure™ Light Source (FOLS)

NSN: 6035-01-509-2511

Part# 0700-8500

This universal light source is a sturdy Mini Maglite® with a universal interface. It is perfect for providing a steady, strong light source at one end of a fiber optic cable for visual inspections of continuity. Two AA alkaline batteries are included. The light source comes standard with a universal 2.50mm adapter. Universal 1.25mm and 1.60mm adapters are also available.



Universal 2.50mm adapter  
 Universal 1.25mm adapter  
 Universal 1.60mm adapter

Part# 0799-2090  
 Part# 0799-2091  
 Part# 0799-2092



## Eye Loupe NSN: 6650-01-586-6297

Part# 0700-8710

This 10X eye loupe allows the installer to inspect connector and termini endfaces to determine proper bead size and to examine cleaves. This loupe will fit most eye sockets allowing the installer a "hands-free" view. NAVSEA listed and approved for MIL-STD-2042C applications.



### Dirty Fiber Optic Connectors?

If you think you have problems now, take a look at this!!!

NAVSEA states in MIL-STD-2042-C, Method 6M1 that all fiber optic endfaces are to be cleaned and inspected before you connect them to their respective mated pair. Our cleaning and inspection products are the solution to fix the problem of what to do with dirty connectors!



# Termination Tools

## Crimp Tool w/Dies

\*Crimp Tool for Tight Structured LC (NAVSEA approved)

NSN: 5120-01-645-8087

Crimp Tool for Mil-Spec and Commercial ST

Crimp Tool for TIA 604-3 (SC) NSN: 5120-01-563-6447

Crimp Tool for OFS Fitel LC (NAVSEA approved)

Crimp Tool for MIL-PRF-29504/14 and M29504/15

NSN: 5120-01-419-3730

Part# 0700-1825

Part# 0700-1855

Part# 0700-1875

Part# 0700-1885

Part# 0700-1895

0700-1825



0700-1855



0700-1875



0700-1885



0700-1895



## Crimp Frame and Dies

Universal Frame (fits all crimp dies) NSN: 5120-01-563-6451

Mil-Spec and Commercial ST NSN: 5120-01-563-6450

\*LC Tight Structured Connectors NAVSEA approved)

COTS/SC – TIA 604-3 (SC) NSN: 5120-01-563-6449

OFS Fitel LC (NAVSEA approved) NSN: 5120-01-645-7414

MIL-PRF-29504/14 and M29504/15 NSN: 5120-01-563-6448

Part# 0700-1830

Part# 0700-1850

Part# 0700-1861

Part# 0700-1870

Part# 0700-1880

Part# 0700-1890

0700-1830



0700-1850



0700-1870



0700-1861



0700-1880



0700-1890



\*Denotes preferred crimp die/tool



# Termination Tools

## Crimp Die to Tool Cross Reference Sheet

Die part#	Description	TL#	Tool part#	TL#	**Cavity sizes	Connector Compatibility/ RPL Part #	**Connector Compatibility/ KITCO Part #	In which kits?	2042 Method
0700-1861	1st or 2nd Generation COTS LC	0118	0700-1825	N/A	2mm modified 2.5mm 2/2.5/3mm 3mm	A-A-59940/1-111SN A-A-59940/1-121SN A-A-59940/1-121DN A-A-59940/1-111DN	0200-2481 0204-6341 0204-6343 0204-6348	0700-9465 0701-1010 0801-8010 0701-7030 0801-8030	5B2
0700-1850	COTS/Mil-Spec ST	N/A	0700-1855	0018	.090" .105" .190"	M83522/16-DNX M83522/16-DNY M83522/16-ANX M83522/16-ANY A-A-59940/3-121SN A-A-59940/3-111SN	0204-4210 0204-4220 0204-4190 M83522/16-ANY 0204-4110 0204-4120	0701-7010 0701-7030 0801-8010 0801-8030	5B1
0700-1870	COTS SC	0119/0120	0700-1875	0019	2mm 2.5mm 2/2.5/3mm 3mm	A-A-59940/2-111SN A-A-59940/2-121SN	0204-6350 0204-6355	0701-7010 0701-7030 0801-8010 0801-8030 0801-8050 0801-8065 0801-8080	5B3
0700-1880	COTS LC	N/A	0700-1885	0116	0.151" 0.178" LC 0.190"	A-A-59940/1-111SP A-A-59940/1-121SP	0204-6330 0204-6335	0700-9465 0701-1010 0801-8010 0701-7030 0801-8030	5B2
0700-1890	Mil-Spec termini	N/A	0700-1895	0017	0.945"	M29504/14-4131C M29504/14-4141C M29504/15-4171C M29504/15-4181C	M29504/14-4131C M29504/14-4141C M29504/15-4171C M29504/15-4181C	0701-7000 0701-7030 0801-8000 0801-8030 0801-8050 0801-8060	5A1

**\*\*The cavity sizes in this column do not reflect or line up with the part numbers listed in the connector compatibility/KITCO part # column. The information given reflects the dimensions of each cavity within that particular crimp die.**

TL#s can be found on the recommended tools tab here: <https://www.navsea.navy.mil/Home/Warfare-Centers/NSWC-Dahlgren/What-We-Do/Navy-Shipboard-Fiberoptics/Recommended-Parts-List/>

RPL can be found on the recommended components parts list tab here: <https://www.navsea.navy.mil/Home/Warfare-Centers/NSWC-Dahlgren/What-We-Do/Navy-Shipboard-Fiberoptics/Recommended-Parts-List/>

2042 Method can be found here: <https://www.navsea.navy.mil/Home/Warfare-Centers/NSWC-Dahlgren/What-We-Do/Navy-Shipboard-Fiberoptics/Design-Standards/Installation-Standards/>

### Torque Wrench

**Part# 0701-3050**

The 0701-3050 torque wrench is used in conjunction with the C-type backshell spanner wrench and backshell grips to torque the M28876 strain relief and backshell backnut to the appropriate torque as outlined in MIL-STD-2042C. NAVSEA listed and approved for MIL-STD-2042C applications. Three sizes of adapters are available.

**0701-3050**



**Size 11 Adapter NSN: 5120-01-420-2445**  
**Size 13 Adapter NSN: 5120-01-420-2444**  
**Size 15 Adapter NSN: 5120-01-420-2446**

**Part# 0701-3530**  
**Part# 0701-3540**  
**Part# 0701-3550**





# M28876 Termination Tools

## Strap Wrench

NSN: 5120-01-037-1395

Part# 0701-3060

The 0701-3060 strap wrench is used to torque the M28876 backshell to the proper level as outlined in the MIL-STD-2042C. Used in conjunction with the 0701-3050 torque wrench and/or the 0701-3520 spanner wrench.

**Note: Two 0701-3060 strap wrenches are required for backshell size 23 applications. NAVSEA listed and approved for MIL-STD-2042C applications.**



## Backshell Spanner Wrench

Use this C-type backshell spanner wrench to torque the backshell and secure the 4, 8, and 31-channel connectors. A properly torqued backshell will ensure lower dB loss in multichannel connectors. NAVSEA listed and approved for MIL-STD-2042C applications.



## 4-Channel/8-Channel (1239109H) 31-Channel

NSN: 5120-01-419-3283

Part# 0701-3520  
Part# 0701-3525

## Micro Torque Tool

Part# 0701-3055

Use the 0701-3055 tool for the installation of the Aptiv split backshell onto an M28876 connector. This tool is set to 4 inch pounds to ensure proper torque.



## 90° Insertion Tool

NSN: 5120-01-649-4855

Part# 0701-3810

Use the 0701-3810 for installation of M29504/14 and M29504/15 termini into straight, 45°, and 90° backshell connectors. NAVSEA listed and approved for MIL-STD-2042C applications.



## Straight Insertion Tool

NSN: 5120-01-144-5338

Part# 0701-3820

Use the 0701-3820 for installation of M29504/14 and M29504/15 termini into straight, 45°, and 90° backshell connectors. NAVSEA listed and approved for MIL-STD-2042C applications.



## Terminus Removal Tool

NSN: 5120-01-631-4246

Part# 0701-3850

Use the 0701-3850 for extraction of M29504/14 and M29504/15 termini from the nest without damaging the termini and endface. This tool is also used to remove the ceramic termini from the 0701-4100 polishing fixture. NAVSEA listed and approved for MIL-STD-2042C applications.



## ASIRT (Alignment Sleeve Insertion and Removal Tool)

NSN: 5120-01-649-4850

Part# 0701-3901

This precision tool will allow the careful removal or installation of M29504/15 alignment sleeves from M28876 multichannel connector nests. The extraction mechanism will remove the alignment sleeve, yet leaves the termini and fiber undamaged. NAVSEA listed and approved for MIL-STD-2042C applications.



## Trinity Insertion/Extraction/ASIRT Kit

Part# 0701-3910

By bundling these 3 tools, the 0701-3820 Straight Insertion Tool, 0701-3850 Extraction Tool and 0701-3901 ASIRT (Alignment Sleeve Insertion/Extraction Tool), a cost savings can be realized.



Call 1.757.518.8100 or visit [www.kitcofiberoptics.com](http://www.kitcofiberoptics.com) 1151 Azalea Garden Road, Norfolk, VA 23502 - Fax 1.757.518.9700

## M28876 Termination Tools

### O-Rings

Use these O-Rings to hold Kevlar™ (aramid yarn) in place during straight backshell installations.

**O-Ring, 2 and 4-channel**

**Part# 0799-2010**

**O-Ring, 8-channel**

**Part# 0799-2012**

**O-Ring, 31-channel**

**Part# 0799-2015**

0799-2010



0799-2015



0799-2012



### O-Ring Installation Tools

Install O-Rings without breaking by using the O-Ring installation tools. Select the appropriate tool to secure the correct sized O-Ring. NAVSEA listed and approved for MIL-STD-2042C applications.

**O-Ring Installation Tool, size 11 (2-channel)** **Part# 0701-3560**

**NSN: 5120-01-424-7866**

**O-Ring Installation Tool, size 13 (4-channel)** **Part# 0701-3570**

**NSN: 5120-01-424-7867**

**O-Ring Installation Tool, size 15 (6/8-channel)** **Part# 0701-3580**

**NSN: 5120-01-424-7868**

**O-Ring Installation Tool, size 23 (31-channel)** **Part# 0701-3590**

**NSN: 5120-01-424-7866**

**O-Ring Lube , 0.28 grams**

**Part# 0701-3710**

0701-3570



0701-3560



0701-3580



0701-3590



0701-3710



## Rotary Mechanical Splice Tools

**UV Curing Lamp w/Base** **NSN: 6250-01-420-6491** **Part# 0700-8915**

A UV curable adhesive is required by the rotary mechanical splice which is cured by an ultra violet light. The 0700-8915 assembly includes the UV Lamp and a custom designed base that holds the splices a specified distance from the light source to assure accurate curing of the adhesive.



**Alignment Clip Tool** **NSN: 5120-01-306-1967** **Part# 0700-3020**

The 0700-3020 alignment clip tool allows the installer to open the rotary mechanical splice's alignment clip and insert the ferrules so that they touch and align.



0700-3020

**Splice Compression Tool** **NSN: 5120-01-376-7721** **Part# 0700-3030**

The 0700-3030 splice compression tool allows the installer to compress the springs that are part of the rotary mechanical splice and to install and remove the splice from the custom tray.

0700-3030



**Rotary Mechanical Splice Polishing Tool** **Part# 0700-4100**

**NSN: 5120-01-328-1227**

The 0700-4100 Rotary Mechanical Splice Polishing Tool will polish the glass ferrules to allow placement into the alignment mechanism. This unique design will allow water from the polishing procedure to be channeled away from the fixture, eliminating fixture "sticking" and allowing for a smoother polishing motion.

0700-4100



# Rotary Mechanical Splice Tools

0700-1590

## UV Adhesive *NAVSEA Listed and approved/MIL-STD-2042C* Part# 0700-1590

Used with Rotary Mechanical Splices and our 0700-8915 oven, this adhesive (MIL-A-24793) comes in a 10 gram bottle.



## Index Matching Gel

Part# 0700-1595

This 1cc syringe of Index Matching Gel is used when installing the MIL-PRF-24623/4-1 rotary mechanical splice. This gel has an index of refraction amazingly similar to the glass used in fiber optic applications. When smeared between the endfaces of rotary mechanical splices or between connector endfaces, much less attenuation occurs due to index of refraction mismatch. NAVSEA listed and approved for MIL-STD-2042C and MIL-PRF-24623 applications.

0700-1595



# Preparation Tools



## 900mm Buffer Stripper NSN: 5110-01-493-2210

Part# 0700-3130

The most popular buffer stripper on the market for 900mm tight buffered cable. This tool mechanically strips fiber coating with no nicks, cuts or scratches.

0700-3130



## 250mm/900mm Buffer Stripper

Part# 0700-3150

This durable .0055" (.14mm) factory set precision tool makes quick work of stripping even the toughest acrylate coated fibers from both 250mm and 900mm cables. The cutting surface is machine hardened, ensuring a smooth, clean stripping action.

0700-3150



## Jacket Strip Tool

Part# 0700-3065

This economical Jacket Strip Tool is perfect for cutting outer jackets of a variety of cables. Adjustable from 10 to 30 AWG.

0700-3065



## OFCC Jacket Strip Tool NSN: 5110-00-246-0975

Part# 0700-3061

Perfect for stripping 10 to 18 AWG (.75 to 4.0mm) cable. This jacket stripper has a spring-release handle and a cushioned grip. NAVSEA listed and approved for MIL-STD-2042C applications.

0700-3061



## Outer Jacket Strip Tool NSN: 5110-01-419-3137

Part# 0700-1240

Strip the outer jacket of a fiber optic cable accurately and quickly without damaging the inside components. The outer jacket strip tool has an adjustable blade to cut a cable longitudinally as well as vertically. It is capable of handling cable diameters up to 1.0 inch. NAVSEA listed and approved for MIL-STD-2042C applications.

0700-1240



# Preparation Tools

0700-3070

**Micro Buffer Stripper**    **NSN: 5110-01-612-4650**    **Part# 0700-3070**

This precision tool is designed to strip 900mm fiber optic buffers. A cleaning brush and an extra replacement blade are included. NAVSEA listed and approved for MIL-STD-2042C applications.

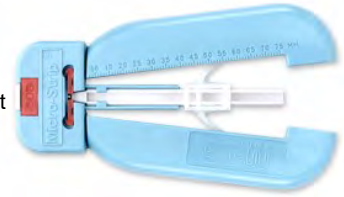

0700-3072

**Thermal Buffer Stripper**    **Part# 0700-3072**

The 0700-3072 Thermal Buffer Stripper uses heat to soften plastic buffers and acrylate coatings to easily strip tough cables.



**Micro/Thermal Buffer Stripper Accessories**

- 125µm Blade Set
- 900µm Guide
- Insertion/Removal Tool
- Cleaning Brush

- Part# 0700-3080
- Part# 0700-3085
- Part# 0700-3090
- Part# 0700-3092

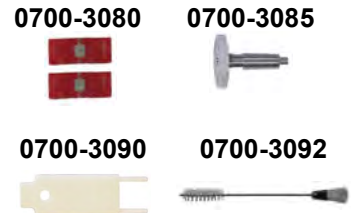

**Spring Lock Kevlar™ Shears**  
**NSN: 5110-01-612-4651**

**Part# 0700-3321**

These high leverage Kevlar™ shears have a non-slip, serrated blade specifically designed to cut Kevlar™. They are made of hot-forged carbon steel and feature a safety device, a quick action spring release and a comfortable rubber-coated handle. NAVSEA listed and approved for MIL-STD-2042C applications.



0700-3321

**Industrial Kevlar™ Shears**  
**NSN: 5110-01-541-8746**

**Part# 0700-3315**

Our new and improved Industrial Kevlar™ Shears, with hardened edge steel blades, are perfect for high volume terminations.



0700-3315

**Fibersure™ Multipurpose Stripping Tool**  
**NSN: 5110-01-559-9272**

**Part# 0700-3125**

KITCO Fiber Optics introduces our new Fibersure™ Multipurpose Stripping Tool. This is truly a one of a kind stripping tool! The Fibersure™ Stripping Tool is designed to remove 2.0mm to 3.0mm jacketed cable and 250µm and 900µm coated fibers.

**NEW DESIGN**



0700-3125

**Fibersure™ Scribe**    **NSN: 5120-01-563-9273**    **Part# 0700-3750**

This unique scribe is a KITCO innovation. Made of proprietary carbide tungsten and sharpened on both ends to a fine razor-sharp edge, the Fibersure™ Scribe's blade has twice the life of ordinary scribes. When the blade gets dull, simply remove and turn the blade around to continue scribing with precision. NAVSEA listed and approved for MIL-STD-2042C applications.

Replacement blades sold separately.



0700-3750



0700-3740



## Preparation Tools

### Debris Bottle

NSN: 8125-01-563-1725

Part# 0700-9977

Disposing of Fiber Shards is of the utmost safety concern. These shards are very dangerous to health if swallowed, got in your eyes, or drawn into the lungs. They may have the same adverse effect as asbestos fibers - can cause cancerous changes. Our debris bottle will dispose of them properly.

0700-9977



## Safety Materials

### Safety Glasses

NSN: 4240-01-561-7694

Part# 0700-8810

These "one size fits all" Safety Glasses are designed for installer comfort as well as safety. Each ear piece has a sliding handle to allow the installer to adjust the glasses for ultimate comfort and vision. The perfectly clear lenses with side shields protect the installers' eyes from UV (ultra violet) light and from flying glass debris. NAVSEA listed and approved for MIL-STD-2042C applications.

0700-8810



### UV "Over Your Glasses" Safety Glasses

Part# 0700-1570

Our UV (ultra violet) blocking glasses serve the same function as the 0700-8810 glasses with one exception; these amber colored glasses will fit over the installers regular eye glasses.

0700-1570



### Microtip Tweezers

NSN: 5120-00-247-0867

Part# 0700-8911

These extra sharp tweezers come in handy for untangling acrylate coated fibers in crowded communication boxes. Tweezers may also be used to remove tiny shards of glass that may have been inadvertently embedded in your skin.

0700-8911



## Safety Kit

### Fiber Optic Safety Kit

Part# 0700-8850

This safety kit contains all of the equipment necessary to ensure a safe working area when terminating, splicing, and polishing fiber optic cables.

This kit contains the following:

- Eye Loupe, 10X
- Safety Glasses
- Microtip Tweezers
- Alcohol Pads
- Debris Bottle
- Safety Mat

0700-8850



safety matters  
SAFETY FIRST



Call 1.757.518.8100 or visit [www.kitcofiberoptics.com](http://www.kitcofiberoptics.com) 1151 Azalea Garden Road, Norfolk, VA 23502 - Fax 1.757.518.9700

## Polishing Tools

### M29504/14 and M29504/15 Polishing Tool NSN: 5120-01-419-3142

Part# 0701-4100

The 0701-4100 Precision Polishing Tool is designed to polish the M29504/14 and M29504/15 (ceramic pin and socket termini). Manufactured to hold the termini perpendicular to the polishing paper, this fixture minimizes fiber undercut to allow for higher mechanical performance. Specifications dictate that this fixture is to be used in all singlemode and multimode applications involving MIL-STD-2042C.



### The ProFixture NSN: 6080-01-563-1720

Part# 0700-1740

The ProFixture is a must have for the professional fiber optic installer. Made of machine hardened tungsten, the ProFixture will not grind away during polishing. Less expensive fixtures leave a residue (actual fixture material) that can scratch and contaminate the fiber endface which can cause increased dB loss and less reliable performance. The ProFixture pays for itself by eliminating costly repairs due to faulty terminations and is designed to be used with ST, SC and FC connectors and most 2.50mm ferruled connectors. The center hole diameter is held to a 2 ten-thousandths of an inch tolerance to maintain the ferrule perpendicular to the polishing surface. The ProFixture is NAVSEA listed and approved for MIL-STD-2042C applications.



### Universal 1.25mm Polishing Tool

Part# 0700-1735

This universal polishing puck can be used to polish any 1.25mm ferruled connector, (LC or MT-RJ) and is made of tempered stainless steel which will last for years. A precision hole will hold the connector ferrule tightly to prevent uneven polishing.



### Economical LC Polishing Tool

Part# 0700-1725

This economical LC polishing puck can be used to polish any LC connector and is made of a copolymer plastic. A precise footprint will hold the connector ferrule tightly to prevent uneven polishing.



## Polishing Plates and Pads

### Glass Polishing Plate NSN: 6080-01-377-4502

Part# 0700-4110

The 0700-4110 polishing plate is used in conjunction with the polishing film to accomplish the polish in accordance with MIL-STD-2042C.



### Resilient Polishing Pads

These polishing pads are used in accordance with MIL-STD-2042C to accomplish a domed endface polish.

#### Resilient Pad, 70 Durometer w/Acrylic Plate

Part# 0700-2000

NSN: 5130-01-540-2937

#### Resilient Pad, 70 Durometer

Part# 0700-2002

NSN: 5130-01-563-4837

#### Resilient Pad, \*90 Durometer

Part# 0700-2045

NSN: 3460-01-646-3863

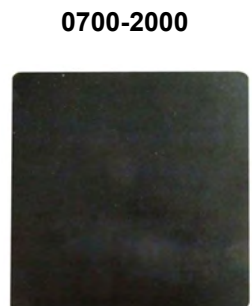

\*The 90 durometer resilient pad is used for 1.25mm, small form factor (LC, MU, MT-RJ) connectors.



Call 1.757.518.8100 or visit [www.kitcofiberoptics.com](http://www.kitcofiberoptics.com) 1151 Azalea Garden Road, Norfolk, VA 23502 - Fax 1.757.518.9700

## Polishing Films

### Polishing Film – Alumina Oxide (AO) and Diamond (5.5" x 5.5" sheets)

**0.3um AO Mylar-Backed Film		<b>Part# 0700-2611</b>
**1.0um AO Mylar-Backed Film	<b>NSN: 5350-01-626-2526</b>	<b>Part# 0700-2621</b>
**0.3um AO Paper-Backed Film		<b>Part# 0700-2510</b>
**8.0um AO Mylar-Backed Film		<b>Part# 0700-2570</b>
3.0um AO Mylar-Backed Film		<b>Part# 0700-2710</b>
**5.0um AO Foam-Backed Film	<b>NSN: 5350-01-420-1454</b>	<b>Part# 0700-2663</b>
**0.1um Diamond Film, 10 per pkg	<b>NSN: 5350-01-545-0206</b>	<b>Part# 0700-2720</b>
0.1um Diamond Film, 3 per pkg	<b>NSN: 5350-01-563-5475</b>	<b>Part# 0700-2803</b>
0.1um Diamond Film, per sheet	<b>NSN: 5350-01-539-0516</b>	<b>Part# 0700-2802</b>
0.5um Diamond Film, 10 per pkg	<b>NSN: 5350-01-552-8188</b>	<b>Part# 0700-2800</b>
1.0um Diamond Film, 10 per pkg		<b>Part# 0700-2805</b>
**Ultrafine Polishing Film (5" round), per sheet	<b>NSN: 5350-01-539-0549</b>	<b>Part# 0700-2850</b>

Unless otherwise noted, all polishing films are sold in packages of 50

\*\*NAVSEA listed and approved for MIL-STD-2042C applications

### Advanced Polishing Solution (Slurry) 4 ounces

**Part# 0700-2860**

#### Polishing Film Colors:

0700-2611	White	0700-2720	Olive Green
0700-2621	Purple	0700-2803	Olive Green
0700-2510	Suede	0700-2802	Olive Green
0700-2570	Dark Grey	0700-2800	Off White/Slate
0700-2710	Pink	0700-2805	Purple
0700-2663	Gray/Slate	0700-2850	Clear

Alumina Oxide Film



Diamond Film



## Adhesives

**Epoxy NAVSEA Listed and approved/MIL-STD-2042C Part# 0700-5035**  
**NSN: 8040-01-421-3510**

**0700-5035**

The epoxy mini 6-pack is a two-part system that uses a resin and a hardener. Conveniently packaged in six 1-gram packages, this epoxy cures in 10 to 30 minutes at 120°C.



### Fibersure Fiber Optic Adhesive

**NSN: 6099-01-563-8571**

**Part# 0700-3810**

### Fibersure Fiber Optic Primer, Non-Hazmat

**NSN: 6099-01-563-8574**

**Part# 0700-3815**

**0700-3810 0700-3815**

The Fibersure anaerobic adhesive system is a two-part system that uses a non-hazmat primer and adhesive. Specially formulated for fiber optic cable, this system provides strong adhesion within seconds to ceramic, stainless steel and most polymer ferrules. Anaerobic adhesives have many advantages which include: quick adhesion for immediate polishing, long-term reliability and repeatability.



**APPROVED FOR EMERGENCY SHIPBOARD COTS USE ONLY!**



Call 1.757.518.8100 or visit [www.kitcofiberoptics.com](http://www.kitcofiberoptics.com) 1151 Azalea Garden Road, Norfolk, VA 23502 - Fax 1.757.518.9700

## Adhesives

### Fibersure Anaerobic Consumables Kit

Part# 0700-3800

0700-3800

This kit contains the following items:

- 1 btl. Primer
- 1 btl. Adhesive
- 10 Alcohol Pads
- 20 Needle Tips

**THIS IS APPROVED FOR COTS USE ONLY!**



## Syringes and Needle Tips

### Syringes and Needle Tips

#### Syringe (3cc)

NSN: 8125-01-562-0534

#### Needle Tip (20 gauge, 1")

NSN: 6515-01-532-2085

#### Syringe w/Needle Tip (24 per pkg)

NSN: 5120-01-539-0526

#### Needle Tip (18 gauge, 1")

NSN: 5120-01-645-7417

Part# 0700-5121

Part# 0700-5111

Part# 0700-5100

Part# 0700-5144

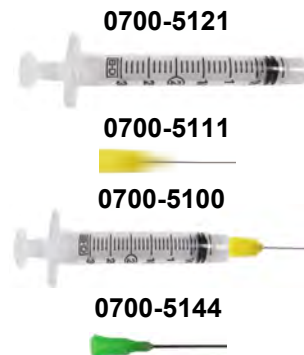

## Cleaning Products

### Canned Air

NSN: 6850-01-517-1506

Part# 3200-4161

This dispenser of compressed canned air provides a tube that securely fits in the nozzle to remove particles from hard to reach areas. The ingredients are environmentally safe.

3200-4161



### Lint Free Wipes

NSN: 7920-01-321-6791 Part# 0700-5200

These absorbing wipes are perfect for cleaning fiber and connector endfaces. Each package contains 100 soft lint-free wipes.

0700-5200



### OPTIPOP Connector Cleaner

Part# 0700-5191

0700-5191

The OPTIPOP is a cassette style fiber optic connector cleaner system that can be refilled for reduced cleaning costs. It uses a densely woven micro-fiber cleaning fabric to remove harmful contaminants from the ferrule endface. The OPTIPOP cleaning tool will accommodate single and multi fiber connections. [Replacement reels \(0700-5192\) can be ordered separately.](#)



### CleanClicker™ Cassette Cleaner™

Part# 0700-5196

0700-5196

The MicroCare CleanClicker™ Cassette Cleaner cleans all the usual connectors such as SC duplex, FC, ST, LC duplex and unmated jumper assemblies as well as the female MPO assemblies



### FiberClean Cleaner

Part# 0795-0990

0795-0990

The FiberClean Cleaner, used to clean the fiber optic connector/termini endface, is compact and can be reloaded over and over, making it cost effective to use. The dispenser protects the reel from dirt and moisture before use, extending the life and quality of the cleaner.



Call 1.757.518.8100 or visit [www.kitcofiberoptics.com](http://www.kitcofiberoptics.com) 1151 Azalea Garden Road, Norfolk, VA 23502 - Fax 1.757.518.9700



# Cleaning Products

## QbE® Lint Free Wipe

**Part# 0700-5190**

The QbE® Lint Free Wipes are designed with a precision wipe platform built onto the side of the box to provide 100% endface coverage ensuring removal of all debris – even on connector edges. 200 sheets per box.



## Alcohol Pads

These alcohol soaked pads are placed in most of our fiber optic tool kits so that the installer will be able to immediately use the kit. Liquid alcohol is not included in our kits because of the hazardous materials restrictions. These wiping pads are saturated with optically pure 99% anhydrous reagent isopropyl alcohol, perfect for cleaning polishing pads, tools and connector endfaces.

### Single Alcohol Pad

**NSN: 6510-01-543-5190**

**Part# 0700-9760**

### Case of 50 Alcohol Pads

**NSN: 6850-01-561-8896**

**Part# 0700-9765**

**0700-9760**



## Isopropyl Alcohol

**Part# 0700-5150**

This 99% anhydrous reagent isopropyl alcohol contains the same fluid that is in our alcohol pads, 0700-9760. This alcohol comes in a 16 ounce bottle and is used in conjunction with our 0700-9750 pump dispenser.

**0700-5150**



## Alcohol Pump Dispenser

**NSN: 4930-01-561-7695**

**Part# 0700-9750**

This pump dispenser allows easy access to alcohol, while protecting its purity. By pressing the top, a small amount of alcohol rises and sits in the reservoir bowl. A one-way valve seals and protects the inside contents from contamination. This dispenser also has a locking spill proof top and a label clearly marked as "ALCOHOL"

**0700-9750**



## Cleaning Wire

**NSN: 9505-01-540-1468**

**Part# 0700-3210**

Used to push broken fibers out of fiber optic connectors, the 0700-3210 cleaning wire will salvage connectors by clearing them to allow prepared fiber to be re-inserted.



**0700-3210**

## Cleaning Kit **NSN: 6080-01-651-8502**

**Part# 0700-5430**

The 0700-5430 contains all the materials you need to clean the M29504 termini, and the SC, ST and LC connectors and M29504/14 and /15 termini.



Call 1.757.518.8100 or visit [www.kitcofiberoptics.com](http://www.kitcofiberoptics.com) 1151 Azalea Garden Road, Norfolk, VA 23502 - Fax 1.757.518.9700

## Cleaning Products

### Field Cleaning Kit

**Part# 0700-5387**

The 0700-5387 contains all the materials you need to clean any 2.5mm ferruled connector — ST, SC and FC.



## NAVSEA approved Consumables Kits

### NAVSEA Consumables Kits

(for M83522/16 connectors, M29504/14 and M29504/15 termini pins and sockets)

The polishing technique outlined in the latest version MIL-STD-2042C requires three polishing papers instead of the traditional two; using 0.1µm, mylar-backed, diamond paper on a 70 durometer resilient pad. These kits come in a soft reusable storage bag. Our multimode and singlemode consumable kit contain material to perform approximately 100 terminations.

#### Multimode

#### Singlemode

**NSN: 6080-01-449-9157**

(includes 70 durometer pad)

**Part# 0801-9050**

**Part# 0801-9060**

**0801-9050**



## Consumables

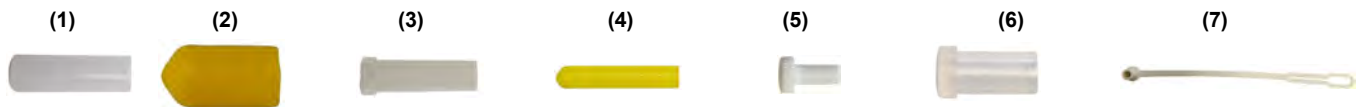

### Dust Caps

Used to protect fiber optic endfaces from dust, dirt, and scratches, dust caps will prolong the life of your fiber optic system.

(1) ST/SC/Termini Ferrule Dust Cap, Clear **NSN: 5340-01-499-5899**

**Part# 0700-9815**

(2) ST Coupling Adapter Dust Cap, Yellow

**Part# 0700-9820**

**NSN: 5430-01-657-7958**

(3) LC Coupling Adapter Dust Cap, White (10 per pkg)

**Part# 0700-9822**

**NSN: 5340-01-608-8055**

(4) Universal 1.60mm Ferrule Dust Cap, Yellow

**Part# 0700-9827**

(5) Universal 1.25mm Ferrule Dust Cap, White (100 per pkg)

**Part# 0700-9828**

(6) Universal 2.50mm Ferrule Dust Cap, Clear

**Part# 0700-9835**

(7) Universal 2.50mm Ferrule Dust Cap w/Lanyard, White

**Part# 0700-9840**

**Unless otherwise noted, all dust caps are sold individually**



Call 1.757.518.8100 or visit [www.kitcofiberoptics.com](http://www.kitcofiberoptics.com) 1151 Azalea Garden Road, Norfolk, VA 23502 - Fax 1.757.518.9700

# Consumables



0700-5185

## STICKLERS® Cleanwipes™

Part# 0700-5185

This lint-free fiber connector cleaner is hermetically sealed in a foil pouch and is ideal for use in harsh environments. The cleaning pad can be used to clean connector endfaces whether dry or moistened with fiber preparation fluid. Sold in a package of 50.



## Fiber Optic Connector Cleaner



Part# 0700-5175

This specially formulated non-hazardous fiber cleaning fluid eliminates unwanted film residue on fiber optic endfaces after cleaning.

0700-5175



## Fiber Preparation Fluid

NSN: 6850-01-546-4699



Part# 0700-9755

The 0700-9755 Fiber Preparation Fluid is engineered to provide a non-flammable, non-hazardous cleaner for use on fiber after stripping, prior to termination or fusion splicing, and for cleaning connector endfaces after polishing. The fluid is packaged in a unique spill proof container with a saturator dispenser tip to provide fast and easy hands-free cleaning, and provides over 400 cleanings per container.

0700-9755



## STICKLERS® Benchtop Cleanwipes™

NSN: 7620-01-547-6547

Part# 0700-5165

These wipes are made from lint-free polyester fabric to provide a stronger, softer and more absorbent wipe than the traditional cellulose wipe. Each mini-tub contains 90 perforated 4" x 2" wipes. The CleanWipes™ package is rugged and spill proof, and protects the wipes from moisture and dust.

0700-5165



## Cleaning Sticks

These cleaning sticks come in 4 different versions for use with M28876 plugs and receptacles, Hermaphroditic connectors, D38999 connectors, MIL-PRF-29504 termini, and SC, ST, FC and LC connectors and adapters.

2.50mm Pin Cleaning Stick, 50 per pkg - SC, ST, FC connectors

Part# 0700-5390

NSN: 6070-01-553-2258

2.50mm Socket Cleaning Stick, 50 per pkg - SC, ST, FC adapters

Part# 0700-5391

NSN: 6070-01-553-2263

1.60mm Cleaning Stick, 50 per pkg - MIL-PRF-29504, MIL-DTL-38999

Part# 0700-5392

NSN: 6070-01-553-2262

1.25mm Cleaning Stick, 50 per pkg - MT-RJ, LC connectors

Part# 0700-5393

NSN: 6070-01-553-2267

1.25mm Cleaning Stick, 50 per pkg - SMA, MPT, Biconic connectors

Part# 0700-5394

NSN: 6070-01-602-2363

6" Wooden Cotton Tip Stick - 100/package

Part# 0701-5201

0700-5390



0700-5391



0700-5392



0700-5393



0700-5394



0701-5201



## Ferrule Mate™ Cleaner

Specially designed for the field technician, the Ferrule Mate™ Cleaner offers a fast, automated way to clean fiber connectors without having to manually change cleaning tips or use special chemicals or tools. Self-advancing cleaning ribbon speeds up cleaning time while ensuring superior results. Each compact and easy to use cleaner performs over **300 cleaning applications** and cleans both PC and angle PC connectors. Available in the SFM-250 model for 2.50mm SC, ST, and FC connectors and adapters and the SFM-125 model for 1.25mm LC and MU connectors and adapters.

**Ferrule Mate™ 2.50mm**  
**Ferrule Mate™ 1.25mm**

**Part# 0795-0995**  
**Part# 0795-0996**



0795-0995

0795-0996



## IBC™ Cleaner

The IBC™ Cleaners are mechanical cleaning tools designed to clean connector endfaces while installed in adapters. The IBC™ cleaning tools use a novel dry cleaning strand to gently sweep and lift away dust and residues from the connector endface. Each compact and easy to use cleaner performs over **525 cleaning applications** and cleans both PC and angle PC connectors.

**2.50mm Cleaner – SC, ST, FC, connectors and TFOCA termini**  
**1.25mm Cleaner – MT-RJ, MU, LC connectors**  
**2.00mm Cleaner – MIL-PRF-29504 termini**  
**1.60mm Cleaner – MIL-DTL-38999 termini**  
**2.50mm Cleaner – SC connectors and adapters**

**Part# 0700-5396**  
**Part# 0700-5397**  
**Part# 0700-5398**  
**Part# 0700-5399**  
**Part# 0700-5450**



## CleanBeam Mil Kit

**Part# 0700-5425**

0700-5425

The CleanBeam Mil Kit is designed to provide the highest level of cleaning for military, tactical, shipboard and commercial fiber optic plugs and sockets. The CleanBeam wet-to-dry cleaning system provides superior cleaning results while eliminating unwanted film residue on glass surfaces, improving system performance, and preventing damage to expensive equipment and testers.

This kit contains the following:

- STICKLERS™ Fiber Optic connector cleaner
- QbE® lint free wipes
- 2.50mm cleaning stick, 50 per pkg – SC, ST, FC connectors
- 2.50mm cleaning stick, 50 per pkg – SC, ST, FC adapters
  - 1.60mm cleaning stick, 50 per pkg – MIL-PRF-29504 and MIL-DTL-38999



# Measurement Quality Jumpers

## Why use MQJs?

Consistency, repeatability, flexibility, and accuracy. Even though the power meter is “zeroed-out” before being attached to the cable to be tested, the quality of reference cables can greatly affect your testing results. The use of MQJs minimizes harmful effects. MQJs fall within a testing range that ensures no matter which MQJ you use, your results will be consistent and repeatable. If various tests must be performed at different times, the results will be consistent because MQJs (by definition) yield consistent results.

## What are MQJs?

MQJs (Measurement Quality Jumpers) are reference cables or test jumpers that are manufactured and tested to meet the highest levels of optical performance, while allowing repeatability and flexibility in testing fiber. An MQJ will not pass a sub-standard component or link, nor will it fail a good component or link.

## Why is the one jumper method prescribed?

Many installers use the two (or three) jumper reference method for all of their testing requirements, regardless of the cable plant configuration. The two (or three) jumper reference methods can, however, understate the actual link loss. The one jumper reference method will approximate the installed performance loss more closely and will result in the safest and most conservative test results. In accordance with MIL-STD-2042C, part 6, the one jumper reference method is the correct method for measuring link loss. This procedure is also the accepted method for measuring link loss according to ANSI-TIA 568.C.0-2, Annex E in accordance with TIA 526-7, Annex A, Method A-1 for [singlemode applications](#) and TIA 526-14-B, Annex A, Method A-1 for [singlemode applications](#).

## Manufacturing and verifying MQJs

In order to manufacture MQJs, extensive testing verification procedures must be followed. During the test procedure, each connector is mated and de-mated 10 times. Not only must an MQJ fall within the range mentioned in Table 1 on the following page, it must also consistently fall within these prescribed ranges. The mean and standard deviation of these measurements are calculated and verified to fall within these prescribed ranges. The navy requires MQJs to be manufactured using connectors made in accordance with MIL-C-83522/16, MIL-PRF-28876 or MIL-PRF-29504/14 and MIL-PRF-29504/15 specifications. The fiber must meet MIL-PRF-49291 specifications and the jacketed cable must meet MIL-PRF-85045 criteria.

## In conclusion

KITCO has chosen to take the lead and is committed to ensure that fiber optic testing be performed solely with the use of the highest quality test jumpers - MQJs. The benefits of using MQJs are clear; consistency, repeatability, flexibility and accuracy!

## Loss Acceptance Criteria for MQJs

### Multimode 62.5/125µm

End Connection  
MIL-C-83522/16  
Acceptable Loss (dB)  
 $0.00 < BST < 0.35$   
Standard Deviation (dB)  
.05 (max)

End Connection  
MIL-T-29504/14 Pin  
Acceptable Loss (dB)  
 $0.00 < BC < 0.70$   
Standard Deviation (dB)  
.05 (max)

End Connection  
MIL-T-29504/15 Socket  
Acceptable Loss (dB)  
 $0.00 < BC < 0.70$   
Standard Deviation (dB)  
.05 (max)

End Connection  
MIL-S-24623 Splice  
Acceptable Loss (dB)  
 $0.00 < BC < 0.30$   
Standard Deviation (dB)  
.05 (max)

End Connection  
TIA 604-10/LC  
Acceptable Loss (dB)  
 $0.00 < BST < 0.35$   
Standard Deviation (dB)  
.05 (max)

### Multimode 50/125µm

End Connection  
MIL-C-83522/16  
Acceptable Loss (dB)  
 $0.00 < BST < 0.35$   
Standard Deviation (dB)  
.05 (max)

End Connection  
MIL-T-29504/14 Pin  
Acceptable Loss (dB)  
 $0.00 < BC < 0.70$   
Standard Deviation (dB)  
.05 (max)

End Connection  
MIL-T-29504/15 Socket  
Acceptable Loss (dB)  
 $0.00 < BC < 0.70$   
Standard Deviation (dB)

### Singlemode 8.3/125µm

End Connection  
MIL-C-83522/16  
Acceptable Loss (dB)  
 $0.00 < BST < 0.35$   
Standard Deviation (dB)  
.10 (max)

End Connection  
MIL-T-29504/14 Pin  
Acceptable Loss (dB)  
 $0.00 < BC < 0.70$   
Standard Deviation (dB)  
.05 (max)

End Connection  
MIL-T-29504/15 Socket  
Acceptable Loss (dB)  
 $0.00 < BC < 0.70$   
Standard Deviation (dB)  
.05 (max)

End Connection  
MIL-S-24623 Splice  
Acceptable Loss (dB)  
 $0.00 < BC < 0.30$   
Standard Deviation (dB)  
.05 (max)

End Connection  
TIA 604-10/LC  
Acceptable Loss (dB)  
 $0.00 < BST < 0.35$   
Standard Deviation (dB)  
.10 (max)

### The Navy requires...

*The use of MQJs (Measurement Quality Jumpers) in accordance with the NAVSEA Drawing #'s 6877804 and 8324329 when testing shipboard based optical fiber cable plants per MIL-STD-2042C. MQJs are available for both multimode (62.5/125 and 50/125) and single-mode enhanced applications.*



# Measurement Quality Jumpers

## NAVSEA Drawings for Multimode MQJs

<u>NAVSEA Drawing#</u>	<u>NSN</u>	<u>Description</u>	<u>Length</u>	<u>Part#</u>
6877804-01	6020-01-417-1963	ST-ST, 62.5/125µm	50 meters	KFO 60110
6877804-02	6020-01-425-9732	ST-RMS, 62.5/125µm	50 meters	KFO 60210
6877804-03	6020-01-417-1964	ST-pin, 62.5/125µm	50 meters	KFO 60310
6877804-04	6020-01-417-1967	ST-socket, 62.5/125µm	50 meters	KFO 60410
6877804-05	6020-01-417-5230	ST-ST, 62.5/125µm	1 meter	KFO 60510
6877804-06	6020-01-425-9721	ST-RMS, 62.5/125µm	1 meter	KFO 60610
6877804-07	6020-01-417-5244	ST-4 fiber plug, 62.5/125µm	1 meter	KFO 60710
6877804-08	6020-01-418-6285	ST-4 fiber receptacle, 62.5/125µm	1 meter	KFO 60810
6877804-09	6020-01-425-9727	ST-8 fiber plug, 62.5/125µm	1 meter	KFO 60910
6877804-10	6020-01-425-9730	ST-8 fiber receptacle, 62.5/125µm	1 meter	KFO 61010
6877804-12	6625-01-495-7550	ST-31 fiber plug, 62.5/125µm	1 meter	KFO 61210
6877804-13	6625-01-495-7552	ST-31 fiber receptacle, 62.5/125µm	1 meter	KFO 61310
6877804-14	6020-01-692-6310	ST-LC, 62.5/125µm	50 meters	KFO 61410
6877804-15	6020-01-692-6302	ST-LC, 62.5/125µm	1 meter	KFO 61510
8324329-01	6060-01-607-2009	ST-ST, 50/125µm	50 meters	KFO 65110
8324329-02	N/A	ST-pin, 50/125µm	50 meters	KFO 65310
8324329-03	N/A	ST-socket, 50/125µm	50 meters	KFO 65410
8324329-04	6060-01-607-2617	ST-ST, 50/125µm	1 meter	KFO 65510
8324329-05	6060-01-607-2622	ST-8 fiber plug, 50/125µm	1 meter	KFO 65910
8324329-06	6060-01-607-2002	ST-8 fiber receptacle, 50/125µm	1 meter	KFO 65010

## NAVSEA Drawings for Singlemode Enhanced MQJs

<u>NAVSEA Drawing#</u>	<u>NSN</u>	<u>Description</u>	<u>Length</u>	<u>Part#</u>
6877804-01SME	6625-01-498-9987	ST-ST, 9.0/125µm	50 meters	KFO 60130
6877804-03SME	6625-01-498-9980	ST-pin, 9.0/125µm	50 meters	KFO 60330
6877804-04SME	6625-01-498-9988	ST-socket, 9.0/125µm	50 meters	KFO 60430
6877804-05SME	6625-01-498-9998	ST-ST, 9.0/125µm	1 meter	KFO 60530
6877804-07SME	6625-01-496-9904	ST-4 fiber plug, 9.0/125µm	1 meter	KFO 60730
6877804-08SME	6625-01-496-9906	ST-4 fiber receptacle, 9.0/125µm	1 meter	KFO 60830
6877804-09SME	6625-01-496-9913	ST-8 fiber plug, 9.0/125µm	1 meter	KFO 60930
6877804-10SME	6625-01-496-9910	ST-8 fiber receptacle, 9.0/125µm	1 meter	KFO 61030
6877804-12SME	6625-01-496-9911	ST-31 fiber plug, 9.0/125µm	1 meter	KFO 61230
6877804-13SME	6625-01-496-9912	ST-31 fiber receptacle, 9.0/125µm	1 meter	KFO 61330
6877804-14SME	6020-01-692-6309	ST-LC, 9.0/125µm	50 meter	KFO 61430
6877804-15SME	6020-01-926-6307	ST-LC, 9.0/125µm	1 meter	KFO 61530

## Multimode Commercial Certified MQJs (CCMQJ)

<u>Description</u>	<u>Length</u>	<u>Part#</u>
ST-socket, 62.5/125µm	1 meter	KFO 10026
ST-pin, 62.5/125µm	1 meter	KFO 10027
SC-LC, 62.5/125µm	1 meter	KFO 12127
ST-SC, 50/125µm	1 meter	KFO 15361
ST-LC, 50/125µm	1 meter	KFO 13064
LC-LC, 62.5/125µm	1 meter	KFO 15677
SC-SC, 62.5/125µm	1 meter	0705-5320
ST-SC, 62.5/125µm	1 meter	0705-5330

## Singlemode Enhanced Commercial Certified MQJs (CCMQJ)

<u>Description</u>	<u>Length</u>	<u>Part#</u>
ST-socket, 9.0/125µm	1 meter	KFO 10024
ST-pin, 9.0/125µm	1 meter	KFO 10025
SC-LC, 9.0/125µm	1 meter	KFO 12128
LC-LC, 9.0/125µm	1 meter	KFO 13609
SC-SC, 9.0/125µm	1 meter	0705-5325
ST-SC, 9.0/125µm	1 meter	0705-5331

**NOTE: Not all connector types are listed. Any of the CCMQJs can be customized to meet your specific interface and length requirements, please call for details.**



Call 1.757.518.8100 or visit [www.kitcofiberoptics.com](http://www.kitcofiberoptics.com) 1151 Azalea Garden Road, Norfolk, VA 23502 - Fax 1.757.518.9700

# Measurement Quality Jumpers

## Reference Cable Set-Up Configuration NAVSEA Drawing#’s 6877804 and 8324329

These charts depict how MQJs should be set up in relation to an approved light source and power meter. Refer to these charts to utilize MQJs to check for link loss of fiber plants aboard Navy vessels.

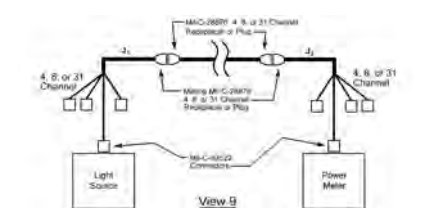
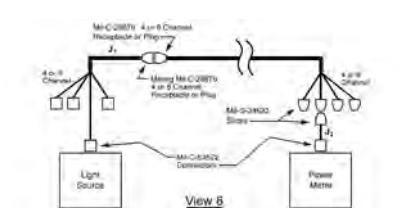
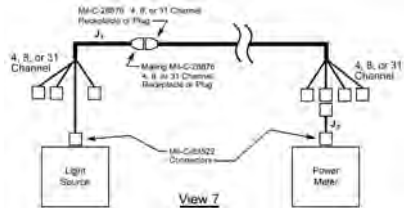
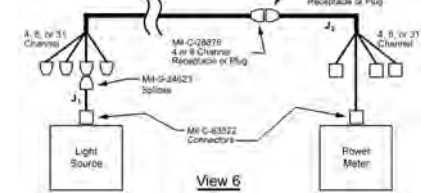
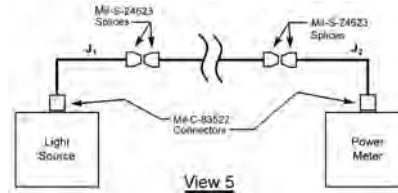
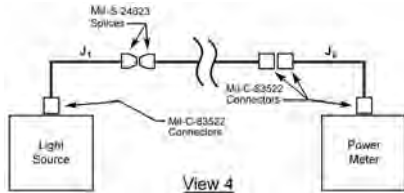
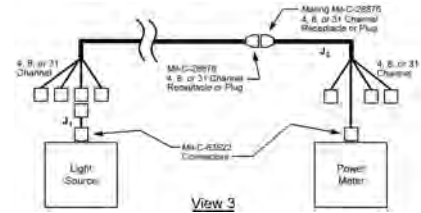
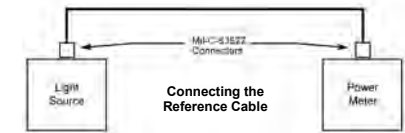
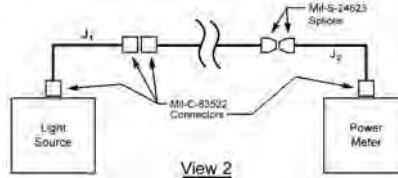
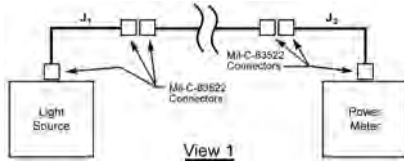

Termination at Light Source End	Source Jumper J <sub>1</sub> Configuration	Termination at Power Meter End	Source Jumper J <sub>2</sub> Configuration	View Figure:
M83522/16	A	M83522/16	A	1
M83522/16	A	M24623	B	2
M83522/16	A	M28876 4-Channel Plug (Receptacle)	C(D)	3
M83522/16	A	M28876 8-Channel Plug (Receptacle)	E(F)	
M83522/16	A	M28876 31-Channel Plug (Receptacle)	G(H)	
M28876 4-Channel Plug (Receptacle)	C(D)	M83522/16	A	7
M28876 8-Channel Plug (Receptacle)	E(F)	M83522/16	A	
M28876 31-Channel Plug (Receptacle)	G(H)	M83522/16	A	
M28876 4-Channel Plug (Receptacle)	C(D)	M28876 4-Channel Plug (Receptacle)	C(D)	9
M28876 8-Channel Plug (Receptacle)	E(F)	M28876 8-Channel Plug (Receptacle)	E(F)	
M28876 31-Channel Plug (Receptacle)	G(H)	M28876 31-Channel Plug (Receptacle)	G(H)	
M24623	B	M83522/16	A	4
M24623	B	M24623	B	5
M24623	B	M28876 4-Channel Plug (Receptacle)	C(D)	6
M24623	B	M28876 8-Channel Plug (Receptacle)	E(F)	
M28876 4-Channel Plug (Receptacle)	C(D)	M24623	B	8
M28876 8-Channel Plug (Receptacle)	E(F)	M24623	B	

SHIPBOARD



# Measurement Quality Jumper Test Set

**Multimode Power Meter/Light Source Test Kit**  
**Multimode/Singlemode Power Meter/Light Source Test Kit**  
**Replacement Multimode MQJ**      **NSN: 6070-01-417-5230**  
**Replacement Singlemode MQJ**    **NSN: 6625-01-498-9998**

**Part# 0701-7045**  
**Part# 0701-8045**  
**Part# KFO 60510**  
**Part# KFO 60530**

## Eliminate Costly Rework

Link loss testing is a critical part of ensuring that any fiber optic installation meets the desired performance criteria. Many installers are not aware of the importance of this testing, or of the need to use only Measurement Quality Jumpers to ensure accuracy.

KITCO Fiber Optics developed these test kits for the U.S. Navy. Reference cables used for link loss testing must use the components listed in NAVSEA Drawing# 6877804.

MQJs are manufactured using high quality connectors with ceramic zirconia ferrules. Our strict assembly and testing procedures allow us to certify only cables that fall within a .01dB to .35dB loss range with a consistency of .05dB standard deviation. Because of these tolerances, an MQJ will correctly reject a link that does not meet the prescribed standards.

The 0701-7045 includes three 1-meter 6877804-05 ST-ST multimode MQJs as well as a precision light source and power meter with .01dB resolution. The light source and power meter are high quality devices that not only pass the required Couple Powered Ratio (CPR) value but have also been approved for use by the U.S. Navy.

The 0701-8045 includes three 1-meter 6877804-05 ST-ST multimode MQJs and three 1-meter 6877804-05SME ST-ST singlemode MQJs and the same precision light source and power meter that comes with the 0701-7045 plus a dual laser source which has been approved for use by the U.S. Navy to conform with their Couple Powered Ratio (CPR) value .

### The 0701-7045 kit contains the following:

- Multimode LED Source
- Quad Power Meter
- MQJ Power Loss Manual
- ST-ST Adapter
- Alcohol Pads
- \*Micro Swabs (10 ea.)
- Multimode ST-ST MQJs
- Soft Case

**\*When purchased outside of this kit; the micro swabs are packaged only in bags of 100**

### The 0701-8045 kit contains the following:

- Multimode LED Source
- Singlemode Lase Source
- Quad Power Meter
- MQJ Power Loss Manual
- ST-ST Adapter
- Alcohol Pads
- \*Micro Swabs (10 ea.)
- Multimode ST-ST MQJs
- Singlemode ST-ST MQJs
- Hard Case

**\*When purchased outside of this kit; the micro swabs are packaged only in bags of 100**



Use the KITCO MJQ Light Source and Power Meter Test Kits to ensure that your installations meet the required performance criteria.

*Always INSPECT (and clean) before you CONNECT!!*



Call 1.757.518.8100 or visit [www.kitcofiberoptics.com](http://www.kitcofiberoptics.com) 1151 Azalea Garden Road, Norfolk, VA 23502 - Fax 1.757.518.9700



# Testing Equipment

## Talk Sets

These Voicelink™ Talk Sets provide the installer or test technician with a quick and simple voice communication link over a single optical fiber. Available in a combination singlemode/multimode fiber talk set, options include either a push-to-talk remote speaker/mic. or a VOX unit with a headset and boom mic. Sold as a pair, the talk sets include a hard sided waterproof carrying case, instruction manual, 2 base units and 2 remote speaker/mics or VOX units.

**Push-to-Talk (remote speaker headset)**  
**Hands Free (VOX and headset w/boom mic)**

**Part# 0705-6020**  
**Part# 0705-6040**

0705-6020



0705-6040



## Visual Fault Finder (VFL)

This Visual Fault Finder (VFL) is an ideal tool to aid in identifying broken fiber optic cables and fiber optic cables with excessive bends. The VFL can also be used to perform continuity checks and aid in the successful termination of pre-stub (pre-polished) fiber optic connectors. The universal adapter accepts any 2.50mm ferrule (other adapters available), allowing a 650nm, Class IIIA (<5mW) laser light to be injected into a fiber. This light enables breaks or sharp bends in a cable to be identified 6-7km away on a singlemode fiber and 4-5km away on multimode fiber.

**VFL w/Universal 2.50mm Adapter**

**NSN: 5120-01-578-3509**

**VFL w/Universal 1.25mm Adapter**

**1.25mm Adapter (red)**

**NSN: 6060-01-646-2739**

**Part# 0705-7080**

**Part# 0705-7075**

**Part# 0705-7086**

0705-7080



0705-7086

0705-7087



**2.00mm Adapter (white)**

**1.60mm Adapter (blue)**

**1.25mm/1.60mm Adapter w/lanyard**

**Part# 0705-7074**

**Part# 0705-7087**

**Part# 0705-7088**

0705-7088



## Optical Loss Tester

Characterizing the insertion loss and return loss of your fiber has never been so easy! Testing fiber optic cable in the field is a time consuming and complicated process, but the 0705-5450 and 0705-5455 simplify acceptance testing by automating the measurement process, informing the user of PASS/FAIL condition on the fiber under test based on user thresholds. Each unit is housed in a rugged rubberized protective case that can stand up to the rigors of the shipboard or field environment. The large backlit screen and sealed membrane panel enable the unit to be used in the harshest of environments. The internal rechargeable batteries provide a continuous 8 hours of operation on a full charge.

Each tester comes with a hard carrying case, instruction manual, data transfer cable, Report Writer software, mandrel wrap, AC adapter/charger, and SC, ST, and FC Universal Connector Interface (UCI) and Snap-On Connector (SOC) adapters.

**Multimode 850nm/1300nm Optical Loss Tester**

**NSN: 6650-01-508-2419**

**Singlemode 1310nm/1550nm Optical Loss Tester**

**NSN: 6650-01-508-2438**

**Part# 0705-5450**

**Part# 0705-5455**



Call 1.757.518.8100 or visit [www.kitcofiberoptics.com](http://www.kitcofiberoptics.com) 1151 Azalea Garden Road, Norfolk, VA 23502 - Fax 1.757.518.9700

# Testing Equipment

## Navy Approved Light Source/Power Meter Set Meets Required CPR Value

**Part# 0705-5347**

TECHLITE™ series of test sets allows technicians to perform precise optical testing in the field. The meter, when operated in absolute power mode, is used to determine the level of optical power being emitted from a transmitter. In relative mode, the meter is used with the included light source to perform fiber loss measurements or splice tuning operations. The meter, in absolute mode, will store the zero reference reading for all four wavelengths independently in non-volatile memory. This allows all zero reference to be taken at one time and also allows the unit to be turned off while moving between locations to preserve battery life. The light source and power meter are high quality devices that not only pass the required Couple Powered Ratio (CPR) value but have been also approved for use by the U.S. Navy.



## Shipboard Multimode OTDR/MQJ Test Set

**Part# 0701-8900**

The 0701-8900 OTDR/MQJ Kit contains the Viavi OTDR T-BERD 4000 Mainframe OTDR system and the appropriate ST-to-ST multimode MQJ's (Measurement Quality Jumpers) launch cables, coupling adapters, and the cleaning supplies to allow the installer to verify cable attenuation in accordance with MIL-STD-2042C. A quad (multimode, 850nm/1300nm and singlemode, 1310nm/1550nm) module and other MQJ-OTDR launch cables may be purchased separately.

This kit contains the following:

- M83522/17-NY Singlemode ST-ST Adapter
- SC-ST Hybrid Coupler
- MQJ, ST-ST, 50 meters, Multimode
- T-BERD 4000 Mainframe OTDR System
- Multimode 850nm/1300nm Module
- FiberTrace Software
- Alcohol Pads
- Lint Free Swabs, 100 per pkg
- Soft Carrying Case



Please refer to the MIL-STD-2042C for exact details concerning the use of OTDRs and other test equipment.

## Multimode/Singlemode OTDR/MQJ Test Set

**Part# 0701-8950**

The 0701-8950 OTDR/MQJ Kit contains the Viavi OTDR T-BERD 4000 Mainframe OTDR system and the appropriate ST-to-ST multimode/singlemode MQJ's (Measurement Quality Jumpers) launch cables, coupling adapters, and the cleaning supplies to allow the installer to verify cable attenuation.

This kit contains the following:

- M83522/17-NY Singlemode ST-ST Adapter
- SC-ST Hybrid Coupler
- MQJ, ST-ST, 50 meters, Multimode
- MQJ, ST-ST, 50 meters, Singlemode
- T-BERD 4000 Mainframe OTDR System
- Quad 850nm/1300nm and 1310nm/1550nm Module
- FiberTrace Software
- Alcohol Pads
- Lint Free Swabs, 100 per pkg
- Soft Carrying Case



Call 1.757.518.8100 or visit [www.kitcofiberoptics.com](http://www.kitcofiberoptics.com) 1151 Azalea Garden Road, Norfolk, VA 23502 - Fax 1.757.518.9700

# Testing Equipment

## Navy Approved Optical Loss Test Set (OLTS) and Optical Return Loss Meter (ORLM) Part# MAX-945-NAV-M2042-KIT

No need to buy separate Multimode and Single mode Testers anymore! Also performs Single Mode ORL. Only unit available in the market that is:

- Approved for MIL-STD-2042C compliance and for Multimode and Single Mode Insertion Loss (IL) and Single Mode Optical Return Loss (ORL) Testing. Including the following MIL-STD-2042-6C Test Methods:
  - 6C1 Cable Assembly Link Loss Test
  - 6E1 Cable Topology End-to-End Attenuation Test
  - 6K1 Cable Assembly Return Loss Test
  - 6L1 Cable TOPOLOGY End-to-End Return Loss Test
- Navy Shipboard Fiber Optics Recommended Test Equipment List Approved  
TS-0004, TS-0004, TS-0005
- Only Test equipment available and approved to GPETE SCAT 4960  
**Replaces both SCAT 4952 and SCAT 4954**
- Meets requirements of Mil-STD-1678A and Navy Multimode and Single Mode Launch conditions.
  - 6401 Single mode optical loss test set (OLTS) performance requirements  
Configuration A and Configuration B
  - 6402 Multimode optical loss test set (OLTS) performance requirements
- Includes Cleaning material complaint to Mil-STD-2042-6C Method
- Includes Inspection Probe complaint to 6M1 - Fiber Optic Connector Inspection and Cleaning (Inboard Only)
- Includes required single strand Multimode and Single Mode MQJs compliant to NAVSEA  
Drawing 6877804-05, 6877804-05SME, 6877804-15 and 6877804-15SME

Features	Benefits	Value
All-in-one design (source, power meter, return loss meter)	No need to purchase and use separate units. Improves test cycle time and reduces equipment logistics	<p align="center"><b>Best Value on Market</b></p> <p align="center"><b>and</b></p> <p align="center"><b>One-Stop-Shopping</b></p>
Equipment approved by Navy technical authority	Produces results accepted by Navy Supervisor/Shipyard representative	
Supports multiple Navy fiber optic test methods with built in software for recording results	Configured to support required Navy test methodology in MIL-STD 2042	
Includes Navy required measurement quality launch cables (MQJs)	Kitted with 4 sets of certified simplex MQJ's; others available when purchasing MAX-945-NAV-M2042-KIT	
Supported with Navy certified training	KITCO is the certified trainer for performing all aspects of shipboard fiber optics	
Other accessories available	Can be supplied with additional products (i.e. fiber end-face inspection probe) that improve the functionality of the MAX-945-NAV-M2042-KIT	



Call 1.757.518.8100 or visit [www.kitcofiberoptics.com](http://www.kitcofiberoptics.com) 1151 Azalea Garden Road, Norfolk, VA 23502 - Fax 1.757.518.9700

# M28876 Connectors

## MIL-PRF-28876 Fiber Optic Connector

Utilizes the MIL-PRF-29504/14 and MIL-PRF-29504/15 Termini

Developed and produced by the MIL-PRF-28876 fiber optic connector features low optical insertion loss, repeatability, exceptional strain relief and reliability in harsh environments. This connector is used extensively by the United States Navy in shipboard applications and has been on the United States Government's Qualified Products List (QPL) since 1983.



### MIL-SPEC CONNECTOR ORDERING NOMENCLATURE

M28876/7 B 1 2 P 1 \*

Connector Type	Strain Relief	MIL-SPEC / Number
Wall Mount Receptacle	None	M28876/1
Wall Mount Receptacle	Straight	M28876/2
Wall Mount Receptacle	45°	M28876/3
Wall Mount Receptacle	90°	M28876/4
In-Line Receptacle	Straight	M28876/5
Plug Connector	None	M28876/6
Plug Connector	Straight	M28876/7
Plug Connector	45°	M28876/8
Plug Connector	90°	M28876/9
Jam Nut Receptacle	None	M28876/11
Jam Nut Receptacle	Straight	M28876/12
Jam Nut Receptacle	45°	M28876/13
Jam Nut Receptacle	90°	M28876/14

When ordering a /1, /6, or /11 connector type that **DOES NOT** require an insert retention nut and pressure sleeve, add N to the end of the part number nomenclature (for example: M28876/1B1S1N)

Keying Position Designator  
1 thru 6

Keying Position Designator  
P = Pin  
S = Socket

Shell Size	Shell Size Designator
13	B
15	C
23	F

# of Cavities	Shell Size	Insert Designator
4	13	1
6	15	2
8	15	1
18	23	2
31	23	1

(Omit if No Strain Relief)

Backshell # Designator	Maximum Allowable Cable Diameter by Shell Size		
	13	15	23
1	.285 (7.24)	.500 (12.70)	.866 (22.00)
2	.346 (8.79)	.250 (6.35)	1.00 (25.40)
3	N/A	.375 (9.53)	.600 (15.24)

For reference only. Accuracy not guaranteed. Unless otherwise specified, dimensions are in inches and (millimeters).



Call 1.757.518.8100 or visit [www.kitcofiberoptics.com](http://www.kitcofiberoptics.com) 1151 Azalea Garden Road, Norfolk, VA 23502 - Fax 1.757.518.9700

# M28876 Connectors

## MIL-PRF-28876 Fiber Optic Connector

Utilizes the MIL-PRF-29504/14 and MIL-PRF-29504/15 Termini

### Wall Mount Receptacle Straight Backshell Configuration

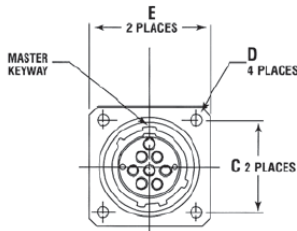

M28876/1

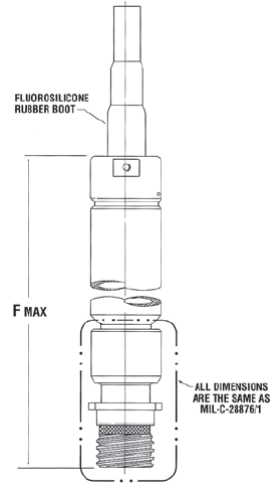
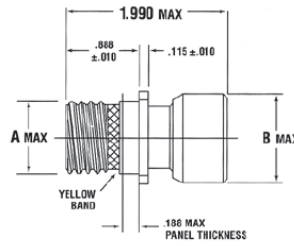

M28876/2

Shell Size	A Max.	B Max.	C	D	E	F Max.	G Max.	H Max.	J Max.	K Max
13	.8750	1.085	.8430	.130	1.158	6.150	6.250	3.580	4.250	4.250
15	1.062	1.257	.9680	.130	1.278	6.150	6.500	3.850	4.500	4.500
23	1.500	1.703	1.281	.130	1.738	6.150	7.500	5.000	5.000	5.000

For reference only. Accuracy not guaranteed.  
Unless otherwise specified, dimensions are in inches.

### Panel Cutout Dimensions

Shell Size	A	B
13	.937	.843
15	1.125	.968
23	1.562	1.281

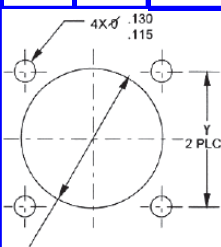

For reference only.  
Accuracy not guaranteed.

### Wall Mount Receptacle 45° Backshell Configuration

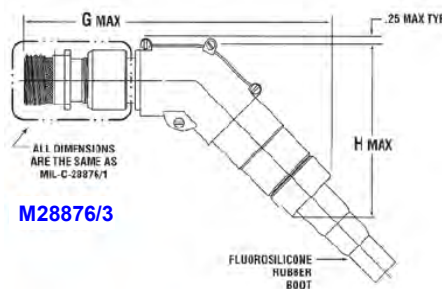

M28876/3

### Wall Mount Receptacle 90° Backshell Configuration

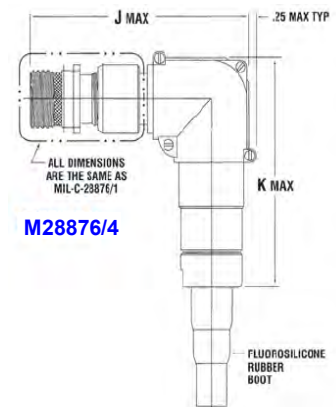

M28876/4

SHIPBOARD



Call 1.757.518.8100 or visit [www.kitcofiberoptics.com](http://www.kitcofiberoptics.com) 1151 Azalea Garden Road, Norfolk, VA 23502 - Fax 1.757.518.9700

# M28876 Connectors

## MIL-PRF-28876 Fiber Optic Connector

Utilizes the MIL-PRF-29504/14 and MIL-PRF-29504/15 Termini

### Plug Connector Straight Backshell Configuration

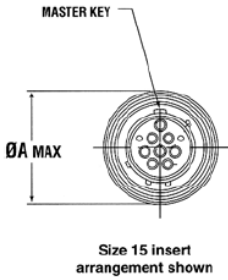

M28876/6

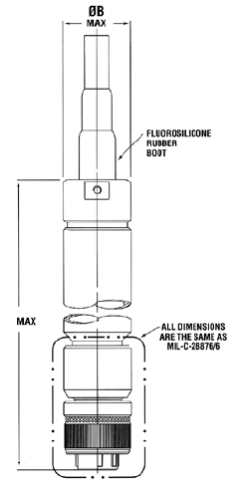
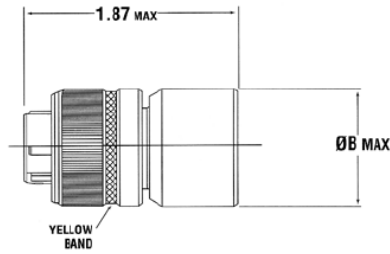

M28876/7

Shell Size	A Max.	B Max.	C Max.	D Max.	E Max.	F Max.	G Max.
13	1.141	1.085	5.960	6.160	3.580	4.190	4.250
15	1.263	1.257	5.960	6.440	3.850	4.440	4.500
23	1.705	1.703	5.960	7.350	5.000	4.850	5.000

For reference only. Accuracy not guaranteed. Unless otherwise specified, dimensions are in inches.

### Plug Connector 45° Backshell Configuration

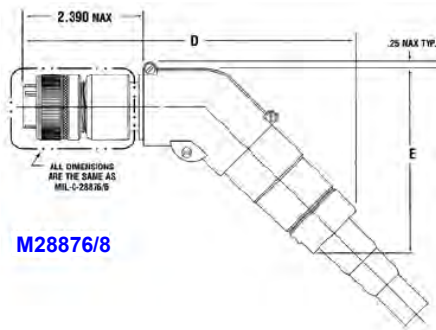

M28876/8

### Plug Connector 90° Backshell Configuration

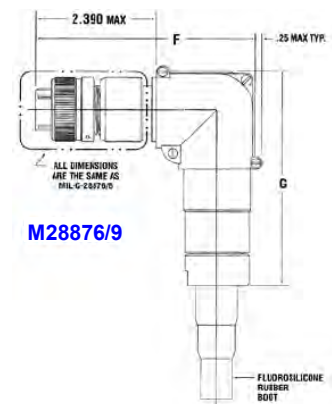

M28876/9



Call 1.757.518.8100 or visit [www.kitcofiberoptics.com](http://www.kitcofiberoptics.com) 1151 Azalea Garden Road, Norfolk, VA 23502 - Fax 1.757.518.9700

# M28876 Connectors

## MIL-PRF-28876 Fiber Optic Connector

Utilizes the MIL-PRF-29504/14 and MIL-PRF-29504/15 Termini

### Jam Nut Receptacle Straight Backshell Configuration



M28876/11

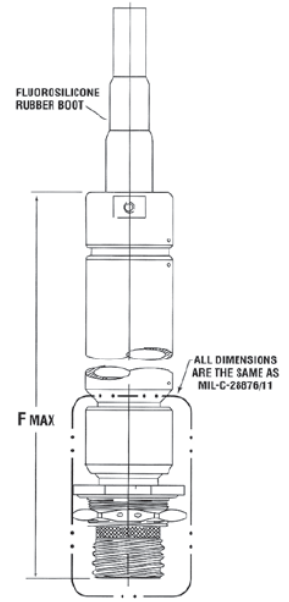
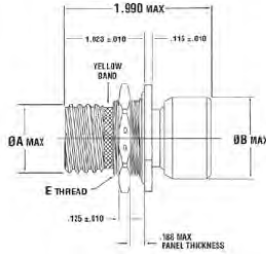

M28876/12

Shell Size	A Max.	B Max.	C	D Hex	E Thread	F Max.	G Max.	H Max.	J Max.	K Max.
13	.8750	1.085	1.508 1.485	1.205 1.117	1.000-20	6.150	6.250	3.580	4.250	4.250
15	1.062	1.257	1.680 1.600	1.392 1.358	1.187-18	6.150	6.500	3.850	4.500	4.500
23	1.500	1.703	2.118 2.095	1.829 1.795	1.625-18	6.150	7.500	5.000	5.000	5.000

For reference only. Accuracy not guaranteed.  
Unless otherwise specified, dimensions are in inches.

### Panel Cutout Dimensions

Shell Size	X +0.005	Y +0.005
13	1.010	.973
15	1.198	1.160
23	1.635	1.598

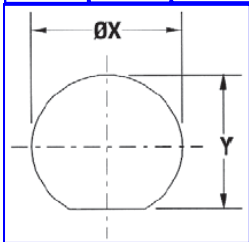

For reference only.  
Accuracy not guaranteed.

### Jam Nut Receptacle 45° Backshell Configuration

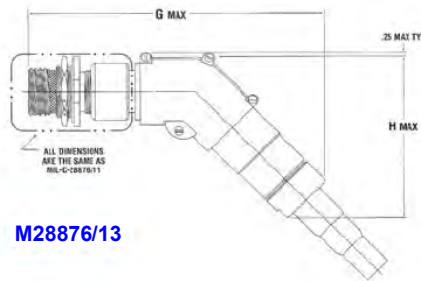

M28876/13

### Jam Nut Receptacle 90° Backshell Configuration

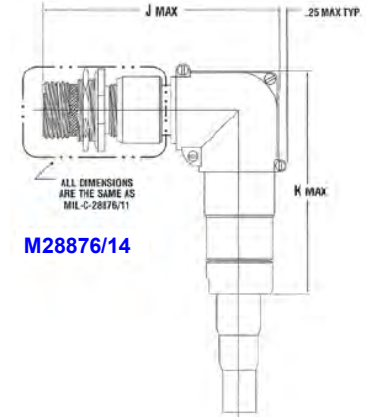

M28876/14



# M28876 Connectors

## MIL-PRF-28876 Keyway Positions

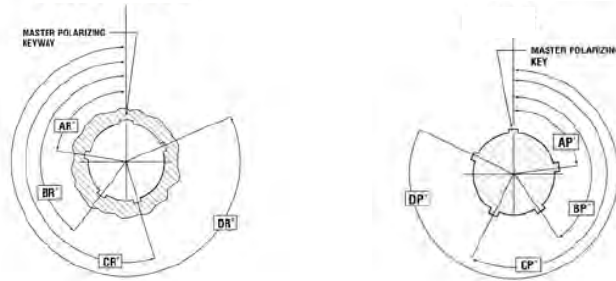

Shell Size	Key and Keyway Arrangement	AR° or AP°	BR° or BP°	CR° or CP°	DR° or DP°
13	0*	-	-	-	-
	1	95	141	208	236
	2	113	156	182	292
	3	90	145	195	252
	4	53	156	220	255
	5	119	146	176	298
	6	51	141	184	242
15 and 23	0*	-	-	-	-
	1	80	142	196	293
	2	135	170	200	310
	3	49	169	200	244
	4	66	140	200	257
	5	62	145	180	280
	6	79	153	197	272

\*0 indicates universal keying position and is available on commercial equivalent connector only.

## MIL-PRF-28876 MIL-SPEC Dust Cover Ordering Nomenclature

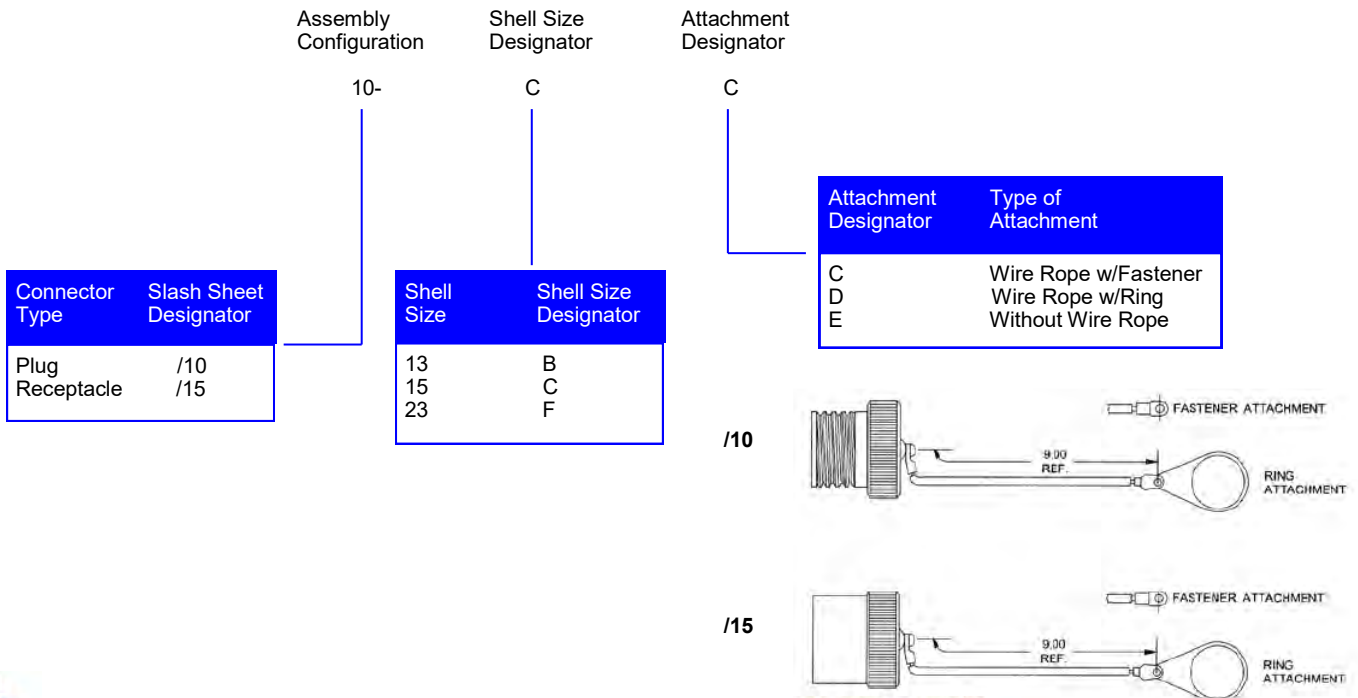

For reference only. Accuracy not guaranteed.



Call 1.757.518.8100 or visit [www.kitcofiberoptics.com](http://www.kitcofiberoptics.com) 1151 Azalea Garden Road, Norfolk, VA 23502 - Fax 1.757.518.9700



# M29504/14 and M29504/15 Termini

MIL-PRF-29504 Fiber Optic Termini

## Ceramic Termini MIL-SPEC Ordering Nomenclature

MIL-SPEC Termini      Terminus Type  
14= Pin, 15= Socket      TICC Dash#      Crimp Sleeve Option\*

**M29504/      YY-      XXXX      C**

TICC Dash#		TICC Dash#		Maximum Fiber Diameter
M29504/14 (Pin)		M29504/15 (Socket)		
Multimode 4131C	Singlemode 4141C	Multimode 4171C	Singlemode 4181C	126.00

For reference only. Accuracy not guaranteed.

\*The "C" indicates that a crimp sleeve for 2.4mm maximum single channel cable is supplied with the terminus. To terminate other size cables, the crimp sleeve must be ordered separately.

M29504/14-4131C



M29504/15-4171C



M29504/14-4141C



M29504/15-4181C



## Pressure Seal Termini

Extreme pressure differentials actually enhance sealing effectiveness, rather than adversely affect it as in conventional connectors. Increasing pressure forces the sealing cup against the contact cavity wall, resulting in superior sealing. The front wiping land, a part of each seal, forms a static seal when inserted into the connector body.

**Pressure Seal Pin**  
**Pressure Seal Socket**

**Part# 4567438-126F000H**  
**Part# 4567439-126F000H**

4567438-126F000H



4567439-126F000H



## Alignment Sleeve (Sold Separately)

**Part# 4569989H**

The alignment sleeve is used to hold the mating ferrule inside the M28876 connector to ensure proper alignment and is the proper sleeve to use with M29504/15 applications.

4569989H



## 2.00mm Crimp Sleeve (Sold Separately)

**Part# 1127696-6S**

The 1127696-6S is the proper crimp sleeve to use with the 0700-1895 crimp tool on 2.00mm jacketed cable for M29504 and hermaphroditic applications.

1127696-6S



## Dummy Terminus

**Part# M29504/03-4038**

The M29504/03-4038 dummy terminus is used to provide a seal if all cavities of an M28876 connector are not being utilized. The M29504/03-4038 is the proper alignment sleeve to use with M29504 applications.

M29504/03-4038



## Pressure Seal Dummy Terminus

**Part# 1020626H**

The 1020626H dummy terminus is used to provide a watertight seal if all cavities of an M28876 connector are not being utilized in connections where fluid sealing is necessary.

1020626H



## Snap Lock Adapters

Apitiv's innovative Snap Lock miniature, single channel, fiber optic connectors will meet your rugged, space limited, cost efficient design requirements without sacrificing performance. Snap Lock's push/pull coupling design provides an efficient mate/demate feature while maintaining the same high optical performance associated with any multi-channel connector.

4568515H



**In-Line Plug**  
**In-Line Receptacle**

**Part# 4568515H**  
**Part# 4568516H**

4568516H



Call 1.757.518.8100 or visit [www.kitcofiberoptics.com](http://www.kitcofiberoptics.com) 1151 Azalea Garden Road, Norfolk, VA 23502 - Fax 1.757.518.9700

## Mil-Spec ST Connectors and Adapters, and Dust Caps

The U.S. Navy specifies (for shipboard applications) that QPL (Qualified Products List) ST connectors are to be used on fiber optic cable plant backbones and all cable drops for tactical applications. KITCO Fiber Optics stocks the QPL MIL-DTL-83522/16-DNX (multimode) and MIL-DTL-83522/16-DNY (singlemode) connectors as well as MIL-DTL-83522/17-NY (multimode/singlemode) coupling adapter.

**Multimode ST (Non-Locking boot)**  
**Singlemode ST (Non-Locking boot)**  
**Multimode ST (Locking boot)**  
**Singlemode ST (Locking boot)**  
**Singlemode/Multimode ST Adapter**  
**M83522/16-EN ST Connector Dust Cap**

**Part# 0204-4210**  
**Part# 0204-4220**  
**Part# 0204-4190**  
**Part# M83522/16-ANY**  
**Part# 0204-4170**  
**Part# 0705-9825**



## Navy Approved COTS ST Connectors and Adapters

### COTS (Commercial Off-the-Shelf) ST Specifications

\*While the Navy specifies that the QPL'd M83522/16 ST connector should be used on all fiber optic cable plant backbones and cable drops, there are some situations where the Navy has approved the use of the following commercial connectors and adapters. See the chart below for details.

<b>Multimode ST</b>	<b>Part# 0204-4120</b>
<b>NSN: 6060-01-485-6592</b>	
<b>Singlemode ST</b>	<b>Part# 0204-4110</b>
<b>NSN: 6060-01-618-4816</b>	
<b>Singlemode/Multimode ST Adapter</b>	<b>Part# 0204-4070</b>
<b>NSN: 6060-01-569-5341</b>	
<b>ST Bare Fiber Adapter</b>	<b>Part# 0200-2640</b>
<b>NSN: 6060-01-561-4181</b>	
<b>Singlemode ST-LC Adapter</b>	<b>Part# 0200-2637</b>
<b>NSN: 6060-01-602-8675</b>	
<b>Singlemode SC-ST Adapter</b>	<b>Part# 0204-1060</b>
<b>NSN: 6060-01-539-3529</b>	



## QPL vs. Navy Approved Commercial ST Connectors

1. QPL ST connectors are to be used on all fiber cable plant backbones.
2. QPL ST connectors are to be used on all cable drops for tactical applications.
3. Navy approved COTS, Commercial ST connectors may be used on cable drops for non-tactical applications.
4. Navy approved COTS, Commercial ST connectors may not be mated to the QPL ST connectors with the stiffer spring constant (such as at the shock mounted rack patch panel).
5. Navy approved COTS, Commercial ST connectors may be used to mate with adapters on commercial interface cards which includes Network Interface Cards (NIC).
6. ST connectors are not to be used on the cabinet exterior and for other external connectors on tactical applications. MIL-PRF -2876 multiple termini connectors are to be used for this application.
7. Since the QPL ST has been know to break off or shear the adapter tabs (pins) on plastic or softer metal ST adapters, they should not be used on these types of commercial interfaces. The Navy approved COTS commercial ST should be used instead.
8. Navy approved COTS commercial ST connectors may be used to mate with equipment and patch panels mounted to the interior of internal or "shock isolated" cabinets for tactical applications.
9. Navy approved COTS commercial ST connectors are not to be used to mate with equipment and patch panels mounted to the interior of in "non-shock isolated" cabinets for tactical applications.



## COTS Termini and Crimp Sleeves

Commercial termini can be used for multimode or singlemode applications and have the same fit, form and function as the MIL-PRF-29504 termini with the exception that the commercial pins and sockets can only be used in non-tactical applications such as those found in NAVSEA's Pierside Connectivity drawings 7325759, 7325760, 7325762 and 7325763. Termini are not supplied with crimp sleeves.

Please specify desired crimp sleeve.

**COTS Ceramic Pin Termini**  
**COTS Ceramic Socket Termini**  
**3.0mm Crimp Sleeve**  
**3.0mm Crimp Sleeve**

**Part# 4569994-126F000H**  
**Part# 4569995-126F000H**  
**Part# 4567761H**  
**Part# 4569486H**



## Navy Approved COTS SC and LC Connectors

### PULL PROOF VS **NON-PULL PROOF** SC AND LC CONNECTORS

•Pull Proof SC and LC connectors are designed for loose structured cables that do not allow the ferrule to move (create an optical disconnect) if the cable/fiber is pulled. This is accomplished by crimping the crimp sleeve to the connector housing and cable. The SC and LC connectors are usually found at electronic ports.

•Non-Pull Proof SC and LC connectors are designed for tight structured cable (mil-spec fiber) to allow the ferrule to move with the cable under spring tension. The crimp sleeve is crimped to the barrel of the connector that is attached to the ferrule within a spring (similar to the ST connector design). The SC and LC connectors are usually found at the passive connection points in the cable plant.

### COTS (Commercial Off-the-Shelf) SC and LC Specifications

The TIA (Telecommunications Industry Association) has accepted the SC (Subscriber Connector) and the LC (Lucent Connector) as the standards for the telecommunications industry. Consequently, electronics that have the SC and LC interface can be found aboard naval vessels. The SC (TIA 604-3) and LC connectors below have been chosen by the Navy as the approved connector to connect to this commercial adapter interface.

**Multimode SC (Non-Pull Proof), 2.00mm boot**  
**Singlemode SC (Non-Pull Proof), 2.00mm boot**  
**Multimode LC Gen II (Non-Pull Proof), 2.00mm boot**  
**Singlemode LC Gen II (Non-Pull Proof), 2.00mm boot**  
**Multimode LC (Pull Proof), 2.00mm boot**  
**Singlemode LC (Pull Proof), 2.00mm boot**  
**Multimode Duplex LC Gen II (Non-Pull Proof)**  
**2.00mm boot**  
**Singlemode Duplex LC Gen II (Non-Pull Proof)**  
**2.00mm boot**

**Part# 0204-6350**  
**Part# 0204-6355**  
**Part# 0200-2481**  
**Part# 0204-6341**  
**Part# 0204-6330**  
**Part# 0204-6335**  
**Part# 0204-6348**  
**Part# 0204-6343**



0204-6335

0204-6348

0204-6343



# COTS SC and LC Adapters

Simplex Singlemode/Multimode LC-LC Coupling Adapter  
 Duplex Singlemode/Multimode LC-LC Coupling Adapter  
 Simplex Singlemode/Singlemode SC-SC Coupling Adapter  
 Simplex Singlemode/Multimode SC-LC Coupling Adapter

Part# 0204-6320  
 Part# 0204-6345  
 Part# 0200-2460  
 Part# 0204-1225



# WidCo Feedthru Strain Relief

KITCO Fiber Optics has designed a complete line of WidCo Feedthru Strain Relief (WFSR) devices that are compatible with M28876 (4, 6 or 8, and 31 channel) plugs and receptacles. These devices are available in two configurations. Configuration A is compatible with the plug-thread side of the M28876 connector. Configuration B is compatible with the backshell-thread side of the M28876 receptacle and the backshell-thread side of the M28876 plug. This concept allows flexibility for the installer who may be faced with space restrictions.

Care was taken in the design of the WFSR to make sure the pressure sleeve (which is included) makes contact with the nest inside the connector to prevent slippage on the backshell side. If the plug side of the M28876 is the side that is strain relieved, the installer should make sure the backnut of the M28876 connector (not pictured) is installed with the pressure sleeve to assure that slippage is strain relieved. The OFCCs (Optical Fiber Cable Component or individual fiber optic strands) will not move if the special gland is activated by tightening the WFSRs OFCC clamp and nut.

### 0900-3230

2 channel, screws onto plug or receptacle backshell threads

- Pressure Sleeve
- Backnut
- OFCC cable clamp w/gland and nut

### 0900-3320

4 channel, screws onto plug or receptacle backshell threads

- Pressure Sleeve
- Backnut
- OFCC cable clamp w/gland and nut

### 0900-3240

6 or 8 channel, screws onto plug or receptacle backshell threads

- Pressure Sleeve
- Backnut

31 channel, screws onto plug or receptacle backshell threads **0900-3160**

- Pressure Sleeve
- Backnut
- OFCC cable clamp w/gland and nut

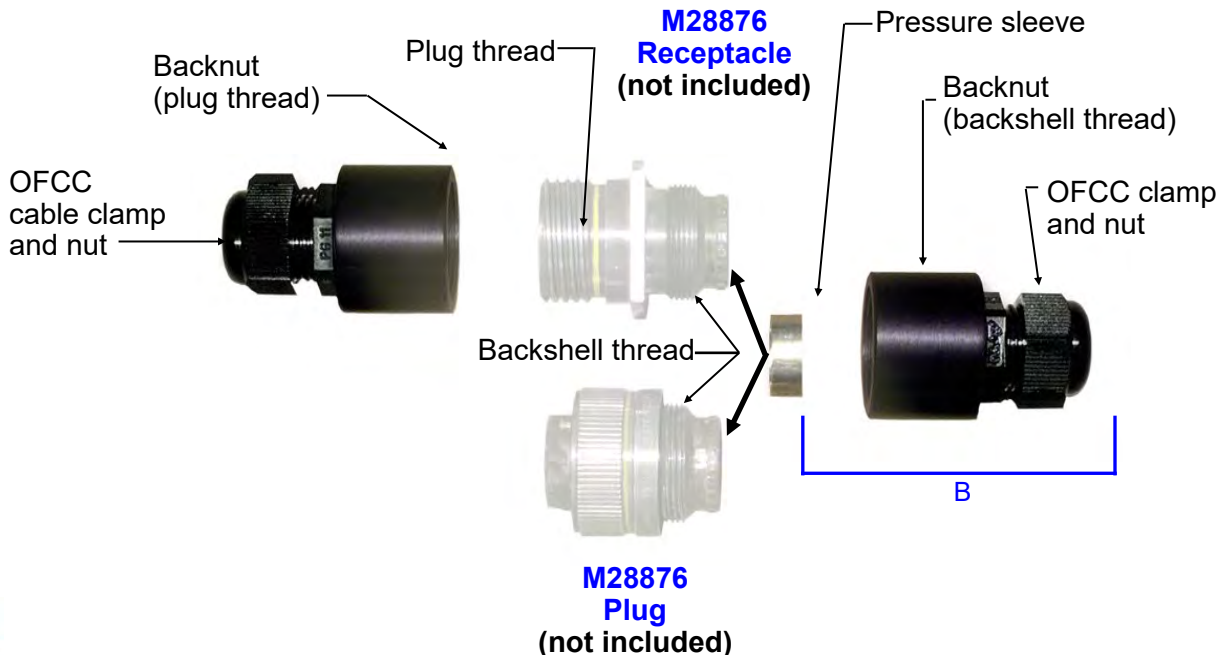

# Technical Services

KITCO's Technical Services Team was a logical outgrowth to our industry training expertise and sets the standard for fiber optic connectivity support. We have extensive experience with fusion and mechanical splicing, shipboard cable termination and Blown Optical Fiber (BOF) installation. Our ETA certified technicians can provide expert on-site assistance for a wide variety of circumstances, ranging from an after-hours emergency to a scheduled SHIPALT upgrade or installation. We have performed installation, repair, alteration and testing support for: CVNs, DDGs, LPDs, LCCs, CGs, SSNs, SSG (2nd Generation), and LCSs. In addition to the various classes of ships, we have performed repairs, alterations, terminations, splicing and testing on the following systems: ACDS, ADMACS/ISIS, ADS, APS, ARCI, ASW (VC-TSC), ATWCS, BEWT, BFTT, BGPHEs, CASS/OMS, CCS, CDL-N, CEC, CSTS, DCQ, ECS, FODMS, GCCS-M, GCS, GEDMS, GPS, IBS, ICAS, IPDS, ISNS, IVN, JSIPS-N, NATO, NAVMACS, NAVSSI, NITES, NSFS, NSSMS, NTCSS, RAIDS, RAM, SASWCS, SIPS, SSDS, SSTD, TAMPs, TESS, TIDS, TMS, TSMS, TSS and VLS. Our technicians have responded to CASREPs, most recently to Jebel Ali, UAE, and performed installation support, troubleshooting, and system inspections for SPAWAR, NAVSEA and local TYCOMS.

As of March 2016, our technicians have completed all eight modules of the NAVSEA 8477552A, Navy Shipboard Fiber Optic Training Certification Program. KITCO's Technical Service Team is prepared to respond to your fiber optic requirements anytime, anywhere.

KITCO Technical Service teams also have experience in shore based installation support. We have performed termination, fusion splicing and testing for the U.S. Senate building, Fort Story Army base, Dam Neck Naval Station, Little Creek Amphibious Base, Norfolk Operational Base, Naval Base Pearl Harbor and Dam Neck Naval Station. Our technicians are familiar with civilian fusion splicing requirements and test in accordance with best industry standards.

Our significant experience in the field allows us to perform scheduled jobs under contract as well as to respond to any emergency situations that may arise. We offer a wealth of knowledge and state-of-the-art termination and test equipment to go along with our technical service project managers and technicians. We believe doing the job correctly the first time will not only reinforce our excellent reputation but augment the value offered to our customer by consistently meeting both time and budget constraints.

## Installation Services

- **Project Management**
- **Logistics Support**
  - Material Control
- **Scheduling**
  - Resources
  - Coordination with Other Trades
- **Budget Constraints**
  - On Time Under Budget
- **Reporting**
  - Daily Report
    - General Reporting
    - Condition Found
    - Completion Report
    - Objective Quality Evidence
    - Test Results
    - Cable Mapping
    - Image Capturing
    - Failure Mode Analysis
    - Archiving
- **BOF Fiber Installation (Certified Technicians)**
  - General Cable
  - Sumitomo Cable
  - Furcation to Splice Trays or Connectors
- **Terminations Exceeding Specifications set forth in (Certified Technicians)**
  - 2042C
  - NSI-009-123
  - Industry (TIA EIA)
- **Field Testing**
  - LS/PM (Light Source/Power Meter)
  - OTDR (Optical Time Domain Reflectometer)
  - Image Capturing (via FO Probes)
  - Cable Mapping
  - Custom Testing as Required
- **Cable Repair**
  - Fusion Splicing
  - Re-Terminations
  - Trouble Shooting

## Design Services

- **Complete Interconnect Solutions**
  - Conventional and BOF (Blown Optical Fiber)
- **Connectivity Design Services**
  - Connectors
  - Cable Assemblies (Internal to Rack)
  - Installation Planning
- **Consultation of both Material and Component Selections**
- **Design of custom components**
  - Strain reliefs
  - Packaging
  - Backshells
  - Connectors
  - Assemblies
- **Certifications**
  - DCAA Compliant Accounting
  - AS9100D and ISO 9001:2015 Certified (Virginia Beach only)
  - Seaport-e



# Certified Fiber Optic Training

Our training division was created to share our broad industry knowledge, and our hands-on training and advanced certification programs have become the hallmarks of our superior reputation. Our trainers have strong credentials including advanced industry certifications and substantial field experience. We have trained thousands of students worldwide on terminating, splicing and testing fiber systems. Our main training facility is located at our headquarters in Virginia Beach, Virginia, and a west coast presence serves San Diego and the surrounding area. Additionally, with our established mobile training services, we have the ability to train at your desired location - anywhere in the world - customizing and tailoring our courses to meet your training requirements.

## NAVSEA and Military

NAVSEA training is mandatory for any person that currently is or has the potential to perform Navy Shipboard fiber optic installations. These personnel include (but not limited to) supervisors, fiber optic QA inspectors, installers/technicians employed by: Ship Builders, SUPSHIP, and Government/Contracted Installation/Repair Teams, AIT's, Ship/Planning Yards, OSR's, RMC's, FMA's, ISEA'S, and Industrial Activities. All personnel that currently are or have the potential of performing Navy shipboard fiber optic installations in any form (e.g., pulling fiber, installing connectors, installing fiber optic interconnection boxes, testing fiber optic links, etc.) shall obtain Navy shipboard fiber optic training from a training organization included on the Certified Fiber Optics Trainers List (CFOTL).

These modules are created and provided by the Certified Organization and are in accordance with the training curriculum requirements, as specified in Section 5 of NAVSEA Drawing 8477552. Any organization responsible for performing fiber optic installations on new construction, alterations, or repairs of ships, whether public or private are required to attend certified training from a Certified Fiber Optic Trainer company maintained by the NSWCDD Fiber Optics Section. KITCO Fiber Optics is pleased to announce we are the first approved Certified Fiber Optic Training Company to offer this training.

In order to more effectively offer this training, KITCO has bundled certain complimentary modules such that multiple modules are presented in a course format

KITCO develops curriculum and provides training world-wide for the U.S. Armed Forces. KITCO is the only company certified by NETC (Naval Education Training Command) to meet the requirements to train Sailors. Over the last decade our KITCO instructors have worked closely with shipyard and Navy personnel terminating and testing fiber optic topologies aboard U.S. Navy ships and submarines. In addition, our instructors collaborated on the design of termination and testing equipment currently specified in MIL-STD-2042B and MIL-STD-2042C sections 5 and 6 (the standard governing the use of fiber on U.S. Navy ships). Using this experience, we provide the only commercially available shipboard training course that teaches fiber principles in strict adherence to Navy standards, and we are working closely with the U.S. Army and Marine Corps to develop battlefield maintenance and fiber optic support training.

- NAVSEA Fiber Optic Installer Training
- NAVSEA Fiber Optic Termination Training
- NAVSEA Fiber Optic Cable Installer Training
- NAVSEA Fiber Optic Installer and BOF Training
- NAVSEA Supervisor and Quality Assurance (QA) Training
- Certified Military Shipboard Training
- Shipboard 38999 Connector Training
- Hermaphroditic Connector Training
- BOF (Blown Optic Fiber) Installation Training
- Military Aviation Technician's Training
- Tactical Fiber Optic Training

## Commercial

We are proud to be one of the nation's premier providers of certified commercial fiber optic training. Our courses are industry recognized and approved for certifications by 3M and KITCO. Industry standards including those of the Telecommunications Industry Association (TIA) and the National Electrical Code (NEC) are incorporated into KITCO's courses. Students are offered the option of taking the Electronics Technicians Association (ETA) Certified Fiber Optic Installer (CFOI) and the Certified Fiber Optics Technician (CFOT) exams.

- Certified Technician Training
- ETA Re-Certification/Refresher Training
- ETA Certification Training

At KITCO we will meet your custom training needs by tailoring any of our courses to meet your training requirements for delivery at your place or ours. While we normally conduct our courses using KITCO provided tools and test equipment, we can also train using your equipment if so desired.



Train with the Most Advanced Equipment



Call 1.757.518.8100 or visit [www.kitcofiberoptics.com](http://www.kitcofiberoptics.com) 1151 Azalea Garden Road, Norfolk, VA 23502 - Fax 1.757.518.9700

# **KITCO**™

*fiber optics*

**Supporting our Warfighters by providing  
premier fiber optic systems and equipment for  
the harshest and most critical strategic military initiatives**



- **Tools & Tool Kits**
- **Test Cables (MQJs)**
- **Custom Cable Assemblies**
- **Connectors**
- **Certified Training**
- **Technical Services**
- **And More**

**KITCO**™  
*fiber optics*

5269 Cleveland Street, Virginia Beach, VA 23462 • Phone: (757) 518-8100 • Fax: (757) 518-9700  
[www.kitcofiberoptics.com](http://www.kitcofiberoptics.com)